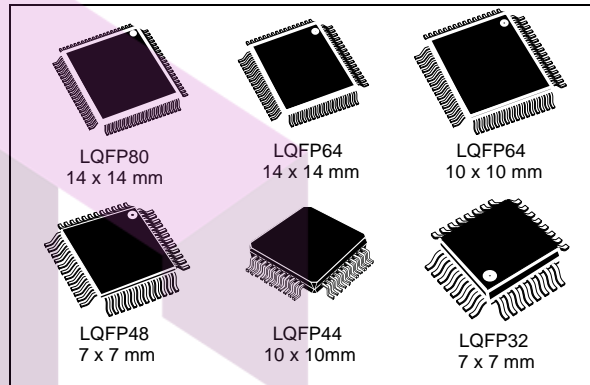


Performance line, 24 MHz STM8S 8-bit MCU, up to 128 KB Flash, integrated EEPROM, 10-bit ADC, timers, 2 UARTs, SPI, I²C, CAN

Datasheet - production data

Features

- Core
 - Max f_{CPU} : up to 24 MHz, 0 wait states @ $f_{\text{CPU}} \leq 16$ MHz
 - Advanced STM8 core with Harvard architecture and 3-stage pipeline
 - Extended instruction set
 - Max 20 MIPS @ 24 MHz
- Memories
 - Program: up to 128 Kbytes Flash; data retention 20 years at 55 °C after 10 kcycles
 - Data: up to 2 Kbytes true data EEPROM; endurance 300 kcycles
 - RAM: up to 6 Kbytes
- Clock, reset and supply management
 - 2.95 to 5.5 V operating voltage
 - Low power crystal resonator oscillator
 - External clock input
 - Internal, user-trimmable 16 MHz RC
 - Internal low power 128 kHz RC
 - Clock security system with clock monitor
 - Wait, active-halt, & halt low power modes
 - Peripheral clocks switched off individually
 - Permanently active, low consumption power-on and power-down reset
- Interrupt management
 - Nested interrupt controller with 32 interrupts
 - Up to 37 external interrupts on 6 vectors
- Timers
 - 2x 16-bit general purpose timers, with 2+3 CAPCOM channels (IC, OC or PWM)
 - Advanced control timer: 16-bit, 4 CAPCOM channels, 3 complementary outputs, dead-time insertion and flexible synchronization
 - 8-bit basic timer with 8-bit prescaler
 - Auto wakeup timer
 - Window watchdog, independent watchdog



- Communications interfaces
 - High speed 1 Mbit/s active beCAN 2.0B
 - UART with clock output for synchronous operation - LIN master mode
 - UART with LIN 2.1 compliant, master/slave modes and automatic resynchronization
 - SPI interface up to 10 Mbit/s
 - I²C interface up to 400 Kbit/s
- 10-bit ADC with up to 16 channels
- I/Os
 - Up to 68 I/Os on an 80-pin package including 18 high sink outputs
 - Highly robust I/O design, immune against current injection
 - Development support
 - Single wire interface module (SWIM) and debug module (DM)
- 96-bit unique ID key for each device

Table 1. Device summary

| Reference | Part number |
|------------|--|
| STM8S207xx | STM8S207MB, STM8S207M8, STM8S207RB, STM8S207R8, STM8S207R6, STM8S207CB, STM8S207C8, STM8S207C6, STM8S207SB, STM8S207S8, STM8S207S6, STM8S207K8, STM8S207K6 |
| STM8S208xx | STM8S208MB, STM8S208RB, STM8S208R8, STM8S208R6, STM8S208CB, STM8S208C8, STM8S208C6, STM8S208SB, STM8S208S8, STM8S208S6 |

Contents

| | | |
|----------|---|-----------|
| 1 | Introduction | 9 |
| 2 | Description | 10 |
| 3 | Block diagram | 12 |
| 4 | Product overview | 13 |
| 4.1 | Central processing unit STM8 | 13 |
| 4.2 | Single wire interface module (SWIM) and debug module (DM) | 14 |
| 4.3 | Interrupt controller | 14 |
| 4.4 | Flash program and data EEPROM memory | 14 |
| 4.5 | Clock controller | 16 |
| 4.6 | Power management | 17 |
| 4.7 | Watchdog timers | 17 |
| 4.8 | Auto wakeup counter | 18 |
| 4.9 | Beeper | 18 |
| 4.10 | TIM1 - 16-bit advanced control timer | 18 |
| 4.11 | TIM2, TIM3 - 16-bit general purpose timers | 18 |
| 4.12 | TIM4 - 8-bit basic timer | 19 |
| 4.13 | Analog-to-digital converter (ADC2) | 19 |
| 4.14 | Communication interfaces | 19 |
| 4.14.1 | UART1 | 20 |
| 4.14.2 | UART3 | 20 |
| 4.14.3 | SPI | 21 |
| 4.14.4 | I ² C | 22 |
| 4.14.5 | beCAN | 22 |
| 5 | Pinouts and pin description | 23 |
| 5.1 | Package pinouts | 23 |
| 5.2 | Alternate function remapping | 32 |
| 6 | Memory and register map | 34 |
| 6.1 | Memory map | 34 |

| | | |
|-----------|---|-----------|
| 6.2 | Register map | 35 |
| 7 | Interrupt vector mapping | 46 |
| 8 | Option bytes | 47 |
| 9 | Unique ID | 51 |
| 10 | Electrical characteristics | 52 |
| 10.1 | Parameter conditions | 52 |
| 10.1.1 | Minimum and maximum values | 52 |
| 10.1.2 | Typical values | 52 |
| 10.1.3 | Typical curves | 52 |
| 10.1.4 | Typical current consumption | 52 |
| 10.1.5 | Pin loading conditions | 53 |
| 10.1.6 | Loading capacitor | 53 |
| 10.1.7 | Pin input voltage | 53 |
| 10.2 | Absolute maximum ratings | 54 |
| 10.3 | Operating conditions | 56 |
| 10.3.1 | VCAP external capacitor | 57 |
| 10.3.2 | Supply current characteristics | 58 |
| 10.3.3 | External clock sources and timing characteristics | 65 |
| 10.3.4 | Internal clock sources and timing characteristics | 67 |
| 10.3.5 | Memory characteristics | 69 |
| 10.3.6 | I/O port pin characteristics | 70 |
| 10.3.7 | Reset pin characteristics | 78 |
| 10.3.8 | SPI serial peripheral interface | 80 |
| 10.3.9 | I ² C interface characteristics | 83 |
| 10.3.10 | 10-bit ADC characteristics | 85 |
| 10.3.11 | EMC characteristics | 88 |
| 11 | Package characteristics | 91 |
| 11.1 | Package information | 92 |
| 11.1.1 | LQFP80 package information | 92 |
| 11.1.2 | LQFP64 package information | 95 |
| 11.1.3 | LQFP48 package information | 99 |
| 11.1.4 | LQFP44 package information | 102 |

| | | |
|-----------|--|------------|
| 11.1.5 | LQFP32 package information | 105 |
| 11.2 | Thermal characteristics | 108 |
| 11.2.1 | Reference document | 108 |
| 11.2.2 | Selecting the product temperature range | 109 |
| 12 | STM8 development tools | 110 |
| 12.1 | Emulation and in-circuit debugging tools | 110 |
| 12.2 | Software tools | 111 |
| 12.2.1 | STM8 toolset | 111 |
| 12.2.2 | C and assembly toolchains | 111 |
| 12.3 | Programming tools | 111 |
| 13 | Ordering information | 112 |
| 14 | Revision history | 113 |



SKYTECH

تهیه و توزیع قطعات الکترونیک

List of tables

| | | |
|-----------|---|----|
| Table 1. | Device summary | 1 |
| Table 2. | STM8S20xxx performance line features | 11 |
| Table 3. | Peripheral clock gating bit assignments in CLK_PCKENR1/2 registers | 16 |
| Table 4. | TIM timer features | 19 |
| Table 5. | Legend/abbreviations for pinout table | 28 |
| Table 6. | Pin description | 28 |
| Table 7. | Flash, Data EEPROM and RAM boundary addresses | 35 |
| Table 8. | I/O port hardware register map | 35 |
| Table 9. | General hardware register map | 37 |
| Table 10. | CPU/SWIM/debug module/interrupt controller registers | 44 |
| Table 11. | Interrupt mapping | 46 |
| Table 12. | Option bytes | 47 |
| Table 13. | Option byte description | 48 |
| Table 14. | Unique ID registers (96 bits) | 51 |
| Table 15. | Voltage characteristics | 54 |
| Table 16. | Current characteristics | 55 |
| Table 17. | Thermal characteristics | 55 |
| Table 18. | General operating conditions | 56 |
| Table 19. | Operating conditions at power-up/power-down | 57 |
| Table 20. | Total current consumption with code execution in run mode at $V_{DD} = 5\text{ V}$ | 58 |
| Table 21. | Total current consumption with code execution in run mode at $V_{DD} = 3.3\text{ V}$ | 59 |
| Table 22. | Total current consumption in wait mode at $V_{DD} = 5\text{ V}$ | 60 |
| Table 23. | Total current consumption in wait mode at $V_{DD} = 3.3\text{ V}$ | 60 |
| Table 24. | Total current consumption in active halt mode at $V_{DD} = 5\text{ V}$, $T_A -40$ to 85° C | 61 |
| Table 25. | Total current consumption in active halt mode at $V_{DD} = 3.3\text{ V}$ | 61 |
| Table 26. | Total current consumption in halt mode at $V_{DD} = 5\text{ V}$ | 62 |
| Table 27. | Total current consumption in halt mode at $V_{DD} = 3.3\text{ V}$ | 62 |
| Table 28. | Wakeup times | 62 |
| Table 29. | Total current consumption and timing in forced reset state | 63 |
| Table 30. | Peripheral current consumption | 63 |
| Table 31. | HSE user external clock characteristics | 65 |
| Table 32. | HSE oscillator characteristics | 66 |
| Table 33. | HSI oscillator characteristics | 67 |
| Table 34. | LSI oscillator characteristics | 68 |
| Table 35. | RAM and hardware registers | 69 |
| Table 36. | Flash program memory/data EEPROM memory | 69 |
| Table 37. | I/O static characteristics | 70 |
| Table 38. | Output driving current (standard ports) | 72 |
| Table 39. | Output driving current (true open drain ports) | 72 |
| Table 40. | Output driving current (high sink ports) | 72 |
| Table 41. | NRST pin characteristics | 78 |
| Table 42. | SPI characteristics | 80 |
| Table 43. | I ² C characteristics | 83 |
| Table 44. | ADC characteristics | 85 |
| Table 45. | ADC accuracy with $R_{AIN} < 10\text{ k}\Omega$, $V_{DDA} = 5\text{ V}$ | 86 |
| Table 46. | ADC accuracy with $R_{AIN} < 10\text{ k}\Omega$, R_{AIN} , $V_{DDA} = 3.3\text{ V}$ | 86 |
| Table 47. | EMS data | 88 |
| Table 48. | EMI data | 89 |

| | | |
|-----------|---|-----|
| Table 49. | ESD absolute maximum ratings | 89 |
| Table 50. | Electrical sensitivities | 90 |
| Table 51. | LQFP80 - 80-pin, 14 x 14 mm low-profile quad flat package mechanical data | 92 |
| Table 52. | LQFP64 - 64-pin, 14 x 14 mm low-profile quad flat package mechanical data | 95 |
| Table 53. | LQFP64 - 64-pin, 10 x 10 mm low-profile quad flat package mechanical data | 96 |
| Table 54. | LQFP48 - 48-pin, 7x 7 mm low-profile quad flat package mechanical | 99 |
| Table 55. | LQFP44 - 44-pin, 10 x 10 mm low-profile quad flat package mechanical data | 103 |
| Table 56. | LQFP32 - 32-pin, 7 x 7 mm low-profile quad flat package mechanical data | 106 |
| Table 57. | Thermal characteristics | 108 |
| Table 58. | Document revision history | 113 |



SKYTECH

تهیه و توزیع قطعات الکترونیک

List of figures

| | | |
|------------|---|----|
| Figure 1. | STM8S20xxx block diagram | 12 |
| Figure 2. | Flash memory organization | 15 |
| Figure 3. | LQFP 80-pin pinout | 23 |
| Figure 4. | LQFP 64-pin pinout | 24 |
| Figure 5. | LQFP 48-pin pinout | 25 |
| Figure 6. | LQFP 44-pin pinout | 26 |
| Figure 7. | LQFP 32-pin pinout | 27 |
| Figure 8. | Memory map | 34 |
| Figure 9. | Supply current measurement conditions | 52 |
| Figure 10. | Pin loading conditions | 53 |
| Figure 11. | Pin input voltage | 53 |
| Figure 12. | f_{CPUmax} versus V_{DD} | 57 |
| Figure 13. | External capacitor C_{EXT} | 57 |
| Figure 14. | Typ. $I_{DD(RUN)}$ vs V_{DD} , HSI RC osc, $f_{CPU} = 16$ MHz | 64 |
| Figure 15. | Typ. $I_{DD(WFI)}$ vs V_{DD} , HSI RC osc, $f_{CPU} = 16$ MHz | 64 |
| Figure 16. | HSE external clock source | 65 |
| Figure 17. | HSE oscillator circuit diagram | 66 |
| Figure 18. | Typical HSI frequency variation vs V_{DD} at 4 temperatures | 67 |
| Figure 19. | Typical LSI frequency variation vs V_{DD} @ 25 °C | 68 |
| Figure 20. | Typical V_{IL} and V_{IH} vs V_{DD} @ 4 temperatures | 71 |
| Figure 21. | Typical pull-up resistance vs V_{DD} @ 4 temperatures | 71 |
| Figure 22. | Typical pull-up current vs V_{DD} @ 4 temperatures | 72 |
| Figure 23. | Typ. V_{OL} @ $V_{DD} = 5$ V (standard ports) | 73 |
| Figure 24. | Typ. V_{OL} @ $V_{DD} = 3.3$ V (standard ports) | 73 |
| Figure 25. | Typ. V_{OL} @ $V_{DD} = 5$ V (true open drain ports) | 74 |
| Figure 26. | Typ. V_{OL} @ $V_{DD} = 3.3$ V (true open drain ports) | 74 |
| Figure 27. | Typ. V_{OL} @ $V_{DD} = 5$ V (high sink ports) | 75 |
| Figure 28. | Typ. V_{OL} @ $V_{DD} = 3.3$ V (high sink ports) | 75 |
| Figure 29. | Typ. $V_{DD} - V_{OH}$ @ $V_{DD} = 5$ V (standard ports) | 76 |
| Figure 30. | Typ. $V_{DD} - V_{OH}$ @ $V_{DD} = 3.3$ V (standard ports) | 76 |
| Figure 31. | Typ. $V_{DD} - V_{OH}$ @ $V_{DD} = 5$ V (high sink ports) | 77 |
| Figure 32. | Typ. $V_{DD} - V_{OH}$ @ $V_{DD} = 3.3$ V (high sink ports) | 77 |
| Figure 33. | Typical NRST V_{IL} and V_{IH} vs V_{DD} @ 4 temperatures | 78 |
| Figure 34. | Typical NRST pull-up resistance vs V_{DD} @ 4 temperatures | 79 |
| Figure 35. | Typical NRST pull-up current vs V_{DD} @ 4 temperatures | 79 |
| Figure 36. | Recommended reset pin protection | 79 |
| Figure 37. | SPI timing diagram - slave mode and $CPHA = 0$ | 81 |
| Figure 38. | SPI timing diagram - slave mode and $CPHA = 1^{(1)}$ | 81 |
| Figure 39. | SPI timing diagram - master mode ⁽¹⁾ | 82 |
| Figure 40. | Typical application with I ² C bus and timing diagram | 84 |
| Figure 41. | ADC accuracy characteristics | 87 |
| Figure 42. | Typical application with ADC | 87 |
| Figure 43. | LQFP80 - 80-pin, 14 x 14 mm low-profile quad flat package outline | 92 |
| Figure 44. | LQFP80 recommended footprint | 93 |
| Figure 45. | LQFP80 marking example (package top view) | 94 |
| Figure 46. | LQFP64 - 64-pin 14 mm x 14 mm low-profile quad flat package outline | 95 |
| Figure 47. | LQFP64 - 64-pin, 10 x 10 mm low-profile quad flat package outline | 96 |
| Figure 48. | LQFP64 - 64-pin, 10 x 10 mm low-profile quad flat recommended footprint | 97 |

| | | |
|------------|--|-----|
| Figure 49. | LQFP64 marking example (package top view) | 98 |
| Figure 50. | LQFP48 - 48-pin, 7 x 7 mm low-profile quad flat package outline | 99 |
| Figure 51. | LQFP48 - 48-pin, 7 x 7 mm low-profile quad flat recommended footprint | 100 |
| Figure 52. | LQFP48 marking example (package top view) | 101 |
| Figure 53. | LQFP44 - 44-pin, 10 x 10 mm low-profile quad flat package outline | 102 |
| Figure 54. | LQFP44 - 44-pin, 10 x 10 mm low-profile quad flat recommended footprint | 104 |
| Figure 55. | LQFP44 marking example (package top view) | 104 |
| Figure 56. | LQFP32 - 32-pin, 7 x 7 mm low-profile quad flat package outline | 105 |
| Figure 57. | LQFP32 - 32-pin, 7 x 7 mm low-profile quad flat recommended footprint | 106 |
| Figure 58. | LQFP32 marking example (package top view) | 107 |
| Figure 59. | STM8S207xx/208xx performance line ordering information scheme ⁽¹⁾ | 112 |



1 Introduction

This datasheet contains the description of the STM8S20xxx features, pinout, electrical characteristics, mechanical data and ordering information.

- For complete information on the STM8S microcontroller memory, registers and peripherals, please refer to the STM8S microcontroller family reference manual (RM0016).
- For information on programming, erasing and protection of the internal Flash memory please refer to the STM8S Flash programming manual (PM0051).
- For information on the debug and SWIM (single wire interface module) refer to the STM8 SWIM communication protocol and debug module user manual (UM0470).
- For information on the STM8 core, please refer to the STM8 CPU programming manual (PM0044).



SKYTECH

تهیه و توزیع قطعات الکترونیک

2 Description

The STM8S20xxx performance line 8-bit microcontrollers offer from 32 to 128 Kbytes Flash program memory. They are referred to as high-density devices in the STM8S microcontroller family reference manual.

All STM8S20xxx devices provide the following benefits: reduced system cost, performance robustness, short development cycles, and product longevity.

The system cost is reduced thanks to an integrated true data EEPROM for up to 300 k write/erase cycles and a high system integration level with internal clock oscillators, watchdog, and brown-out reset.

Device performance is ensured by 20 MIPS at 24 MHz CPU clock frequency and enhanced characteristics which include robust I/O, independent watchdogs (with a separate clock source), and a clock security system.

Short development cycles are guaranteed due to application scalability across a common family product architecture with compatible pinout, memory map and modular peripherals. Full documentation is offered with a wide choice of development tools.

Product longevity is ensured in the STM8S family thanks to their advanced core which is made in a state-of-the-art technology for applications with 2.95 V to 5.5 V operating supply.



Table 2. STM8S20xxx performance line features

| Device | Pin count | Max. number of GPIOs (I/O) | Ext. interrupt pins | Timer CAPCOM channels | Timer complementary outputs | A/D converter channels | High sink I/Os | High density Flash program memory (bytes) | Data EEPROM (bytes) | RAM (bytes) | beCAN interface |
|------------|-----------|----------------------------|---------------------|-----------------------|-----------------------------|------------------------|----------------|---|---------------------|-------------|-----------------|
| STM8S207MB | 80 | 68 | 37 | 9 | 3 | 16 | 18 | 128 K | 2048 | 6 K | No |
| STM8S207M8 | 80 | 68 | 37 | 9 | 3 | 16 | 18 | 64 K | 2048 | 6 K | |
| STM8S207RB | 64 | 52 | 36 | 9 | 3 | 16 | 16 | 128 K | 2048 | 6 K | |
| STM8S207R8 | 64 | 52 | 36 | 9 | 3 | 16 | 16 | 64 K | 1536 | 6 K | |
| STM8S207R6 | 64 | 52 | 36 | 9 | 3 | 16 | 16 | 32 K | 1024 | 6 K | |
| STM8S207CB | 48 | 38 | 35 | 9 | 3 | 10 | 16 | 128 K | 2048 | 6 K | |
| STM8S207C8 | 48 | 38 | 35 | 9 | 3 | 10 | 16 | 64 K | 1536 | 6 K | |
| STM8S207C6 | 48 | 38 | 35 | 9 | 3 | 10 | 16 | 32 K | 1024 | 6 K | |
| STM8S207SB | 44 | 34 | 31 | 8 | 3 | 9 | 15 | 128 K | 1536 | 6 K | |
| STM8S207S8 | 44 | 34 | 31 | 8 | 3 | 9 | 15 | 64 K | 1536 | 6 K | |
| STM8S207S6 | 44 | 34 | 31 | 8 | 3 | 9 | 15 | 32 K | 1024 | 6 K | |
| STM8S207K8 | 32 | 25 | 23 | 8 | 3 | 7 | 12 | 64 K | 1024 | 6 K | |
| STM8S207K6 | 32 | 25 | 23 | 8 | 3 | 7 | 12 | 32 K | 1024 | 6 K | |
| STM8S208MB | 80 | 68 | 37 | 9 | 3 | 16 | 18 | 128 K | 2048 | 6 K | Yes |
| STM8S208RB | 64 | 52 | 37 | 9 | 3 | 16 | 16 | 128 K | 2048 | 6 K | |
| STM8S208R8 | 64 | 52 | 37 | 9 | 3 | 16 | 16 | 64 K | 2048 | 6 K | |
| STM8S208R6 | 64 | 52 | 37 | 9 | 3 | 16 | 16 | 32 K | 2048 | 6 K | |
| STM8S208CB | 48 | 38 | 35 | 9 | 3 | 10 | 16 | 128 K | 2048 | 6 K | |
| STM8S208C8 | 48 | 38 | 35 | 9 | 3 | 10 | 16 | 64 K | 2048 | 6 K | |
| STM8S208C6 | 48 | 38 | 35 | 9 | 3 | 10 | 16 | 32 K | 2048 | 6 K | |
| STM8S208SB | 44 | 34 | 31 | 8 | 3 | 9 | 15 | 128 K | 1536 | 6 K | |
| STM8S208S8 | 44 | 34 | 31 | 8 | 3 | 9 | 15 | 64 K | 1536 | 6 K | |
| STM8S208S6 | 44 | 34 | 31 | 8 | 3 | 9 | 15 | 32 K | 1536 | 6 K | |

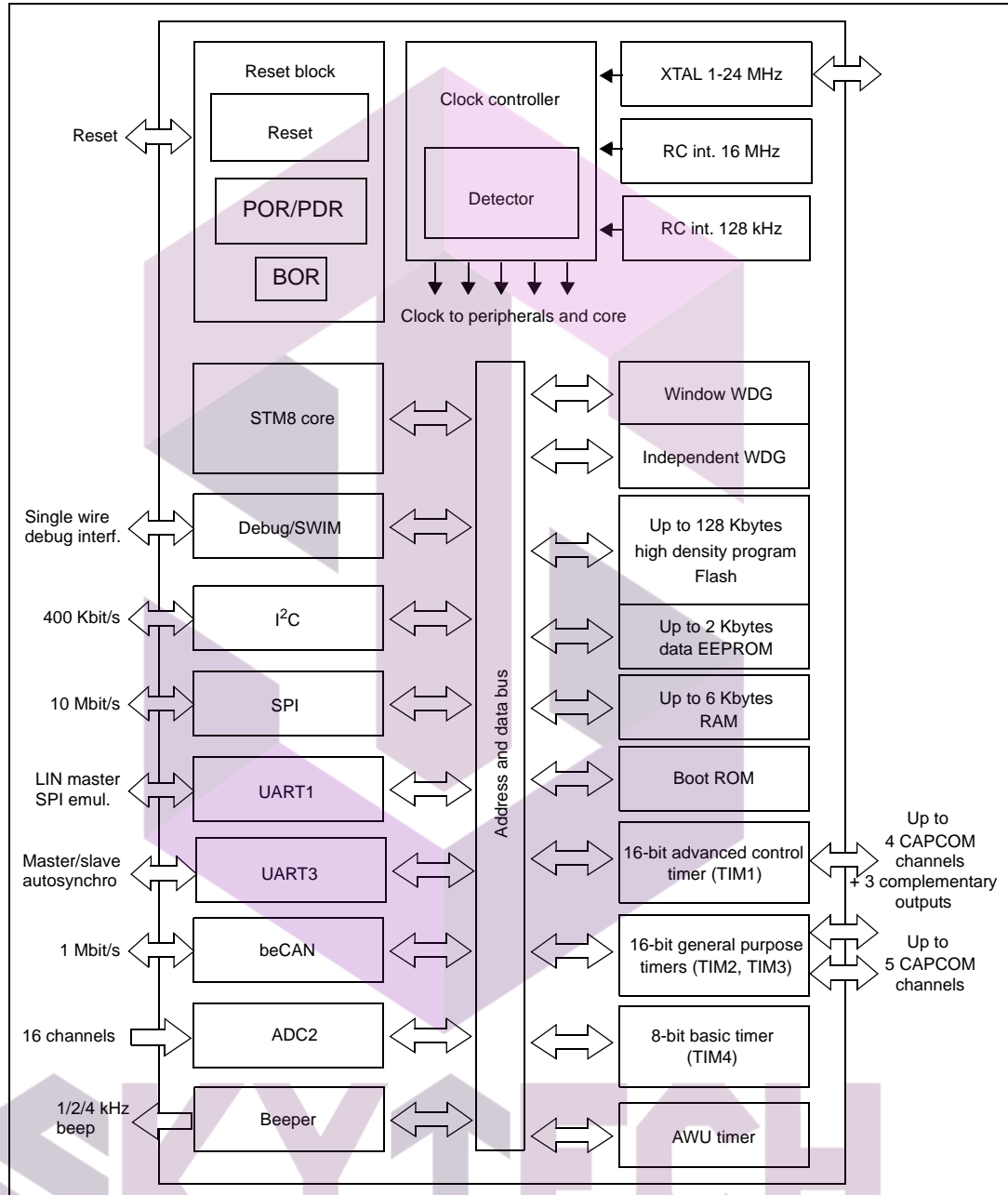


تهیه و توزیع قطعات الکترونیک



3 Block diagram

Figure 1. STM8S20xxx block diagram



- Legend:
 - ADC: Analog-to-digital converter
 - beCAN: Controller area network
 - BOR: Brownout reset
 - I²C: Inter-integrated circuit multimaster interface
 - Independent WDG: Independent watchdog
 - POR/PDR: Power on reset / power down reset
 - SPI: Serial peripheral interface
 - SWIM: Single wire interface module
 - UART: Universal asynchronous receiver transmitter
 - Window WDG: Window watchdog

4 Product overview

The following section intends to give an overview of the basic features of the STM8S20xxx functional modules and peripherals.

For more detailed information please refer to the corresponding family reference manual (RM0016).

4.1 Central processing unit STM8

The 8-bit STM8 core is designed for code efficiency and performance.

It contains 6 internal registers which are directly addressable in each execution context, 20 addressing modes including indexed indirect and relative addressing and 80 instructions.

Architecture and registers

- Harvard architecture
- 3-stage pipeline
- 32-bit wide program memory bus - single cycle fetching for most instructions
- X and Y 16-bit index registers - enabling indexed addressing modes with or without offset and read-modify-write type data manipulations
- 8-bit accumulator
- 24-bit program counter - 16-Mbyte linear memory space
- 16-bit stack pointer - access to a 64 K-level stack
- 8-bit condition code register - 7 condition flags for the result of the last instruction

Addressing

- 20 addressing modes
- Indexed indirect addressing mode for look-up tables located anywhere in the address space
- Stack pointer relative addressing mode for local variables and parameter passing

Instruction set

- 80 instructions with 2-byte average instruction size
- Standard data movement and logic/arithmetic functions
- 8-bit by 8-bit multiplication
- 16-bit by 8-bit and 16-bit by 16-bit division
- Bit manipulation
- Data transfer between stack and accumulator (push/pop) with direct stack access
- Data transfer using the X and Y registers or direct memory-to-memory transfers

تهیه و توزیع قطعات الکترونیک

4.2 Single wire interface module (SWIM) and debug module (DM)

The single wire interface module and debug module permits non-intrusive, real-time in-circuit debugging and fast memory programming.

SWIM

Single wire interface module for direct access to the debug module and memory programming. The interface can be activated in all device operation modes. The maximum data transmission speed is 145 bytes/ms.

Debug module

The non-intrusive debugging module features a performance close to a full-featured emulator. Beside memory and peripherals, also CPU operation can be monitored in real-time by means of shadow registers.

- R/W to RAM and peripheral registers in real-time
- R/W access to all resources by stalling the CPU
- Breakpoints on all program-memory instructions (software breakpoints)
- Two advanced breakpoints, 23 predefined configurations

4.3 Interrupt controller

- Nested interrupts with three software priority levels
- 32 interrupt vectors with hardware priority
- Up to 37 external interrupts on six vectors including TLI
- Trap and reset interrupts

4.4 Flash program and data EEPROM memory

- Up to 128 Kbytes of high density Flash program single voltage Flash memory
- Up to 2K bytes true data EEPROM
- Read while write: Writing in data memory possible while executing code in program memory.
- User option byte area

Write protection (WP)

Write protection of Flash program memory and data EEPROM is provided to avoid unintentional overwriting of memory that could result from a user software malfunction.

There are two levels of write protection. The first level is known as MASS (memory access security system). MASS is always enabled and protects the main Flash program memory, data EEPROM and option bytes.

To perform in-application programming (IAP), this write protection can be removed by writing a MASS key sequence in a control register. This allows the application to write to data EEPROM, modify the contents of main program memory or the device option bytes.

A second level of write protection, can be enabled to further protect a specific area of memory known as UBC (user boot code). Refer to [Figure 2](#).

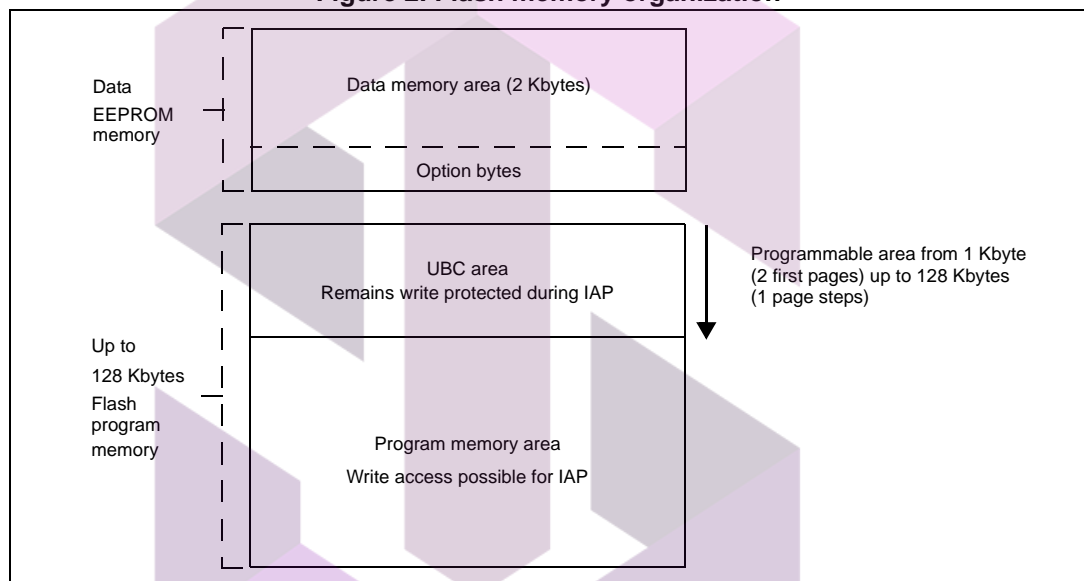
The size of the UBC is programmable through the UBC option byte (*Table 13*), in increments of 1 page (512 bytes) by programming the UBC option byte in ICP mode.

This divides the program memory into two areas:

- Main program memory: Up to 128 Kbytes minus UBC
- User-specific boot code (UBC): Configurable up to 128 Kbytes

The UBC area remains write-protected during in-application programming. This means that the MASS keys do not unlock the UBC area. It protects the memory used to store the boot program, specific code libraries, reset and interrupt vectors, the reset routine and usually the IAP and communication routines.

Figure 2. Flash memory organization



Read-out protection (ROP)

The read-out protection blocks reading and writing the Flash program memory and data EEPROM memory in ICP mode (and debug mode). Once the read-out protection is activated, any attempt to toggle its status triggers a global erase of the program and data memory. Even if no protection can be considered as totally unbreakable, the feature provides a very high level of protection for a general purpose microcontroller.

SKYTECH

تهیه و توزیع قطعات الکترونیک

4.5 Clock controller

The clock controller distributes the system clock (f_{MASTER}) coming from different oscillators to the core and the peripherals. It also manages clock gating for low power modes and ensures clock robustness.

Features

- **Clock prescaler:** To get the best compromise between speed and current consumption the clock frequency to the CPU and peripherals can be adjusted by a programmable prescaler.
- **Safe clock switching:** Clock sources can be changed safely on the fly in run mode through a configuration register. The clock signal is not switched until the new clock source is ready. The design guarantees glitch-free switching.
- **Clock management:** To reduce power consumption, the clock controller can stop the clock to the core, individual peripherals or memory.
- **Master clock sources:** Four different clock sources can be used to drive the master clock:
 - 1-24 MHz high-speed external crystal (HSE)
 - Up to 24 MHz high-speed user-external clock (HSE user-ext)
 - 16 MHz high-speed internal RC oscillator (HSI)
 - 128 kHz low-speed internal RC (LSI)
- **Startup clock:** After reset, the microcontroller restarts by default with an internal 2 MHz clock (HSI/8). The prescaler ratio and clock source can be changed by the application program as soon as the code execution starts.
- **Clock security system (CSS):** This feature can be enabled by software. If an HSE clock failure occurs, the internal RC (16 MHz/8) is automatically selected by the CSS and an interrupt can optionally be generated.
- **Configurable main clock output (CCO):** This outputs an external clock for use by the application.

Table 3. Peripheral clock gating bit assignments in CLK_PCKENR1/2 registers

| Bit | Peripheral clock | Bit | Peripheral clock | Bit | Peripheral clock | Bit | Peripheral clock |
|---------|------------------|---------|------------------|---------|------------------|---------|------------------|
| PCKEN17 | TIM1 | PCKEN13 | UART3 | PCKEN27 | beCAN | PCKEN23 | ADC |
| PCKEN16 | TIM3 | PCKEN12 | UART1 | PCKEN26 | Reserved | PCKEN22 | AWU |
| PCKEN15 | TIM2 | PCKEN11 | SPI | PCKEN25 | Reserved | PCKEN21 | Reserved |
| PCKEN14 | TIM4 | PCKEN10 | I ² C | PCKEN24 | Reserved | PCKEN20 | Reserved |

4.6 Power management

For efficient power management, the application can be put in one of four different low-power modes. You can configure each mode to obtain the best compromise between lowest power consumption, fastest start-up time and available wakeup sources.

- **Wait mode:** In this mode, the CPU is stopped, but peripherals are kept running. The wakeup is performed by an internal or external interrupt or reset.
- **Active halt mode with regulator on:** In this mode, the CPU and peripheral clocks are stopped. An internal wakeup is generated at programmable intervals by the auto wake up unit (AWU). The main voltage regulator is kept powered on, so current consumption is higher than in active halt mode with regulator off, but the wakeup time is faster. Wakeup is triggered by the internal AWU interrupt, external interrupt or reset.
- **Active halt mode with regulator off:** This mode is the same as active halt with regulator on, except that the main voltage regulator is powered off, so the wake up time is slower.
- **Halt mode:** In this mode the microcontroller uses the least power. The CPU and peripheral clocks are stopped, the main voltage regulator is powered off. Wakeup is triggered by external event or reset.

4.7 Watchdog timers

The watchdog system is based on two independent timers providing maximum security to the applications.

Activation of the watchdog timers is controlled by option bytes or by software. Once activated, the watchdogs cannot be disabled by the user program without performing a reset.

Window watchdog timer

The window watchdog is used to detect the occurrence of a software fault, usually generated by external interferences or by unexpected logical conditions, which cause the application program to abandon its normal sequence.

The window function can be used to trim the watchdog behavior to match the application perfectly.

The application software must refresh the counter before time-out and during a limited time window.

A reset is generated in two situations:

1. Timeout: At 16 MHz CPU clock the time-out period can be adjusted between 75 μ s up to 64 ms.
2. Refresh out of window: The downcounter is refreshed before its value is lower than the one stored in the window register.

Independent watchdog timer

The independent watchdog peripheral can be used to resolve processor malfunctions due to hardware or software failures.

It is clocked by the 128 kHz LSI internal RC clock source, and thus stays active even in case of a CPU clock failure

The IWDG time base spans from 60 μ s to 1 s.

4.8 Auto wakeup counter

- Used for auto wakeup from active halt mode
- Clock source: Internal 128 kHz internal low frequency RC oscillator or external clock
- LSI clock can be internally connected to TIM3 input capture channel 1 for calibration

4.9 Beeper

The beeper function outputs a signal on the BEEP pin for sound generation. The signal is in the range of 1, 2 or 4 kHz.

4.10 TIM1 - 16-bit advanced control timer

This is a high-end timer designed for a wide range of control applications. With its complementary outputs, dead-time control and center-aligned PWM capability, the field of applications is extended to motor control, lighting and half-bridge driver

- 16-bit up, down and up/down autoreload counter with 16-bit prescaler
- Four independent capture/compare channels (CAPCOM) configurable as input capture, output compare, PWM generation (edge and center aligned mode) and single pulse mode output
- Synchronization module to control the timer with external signals
- Break input to force the timer outputs into a defined state
- Three complementary outputs with adjustable dead time
- Encoder mode
- Interrupt sources: 3 x input capture/output compare, 1 x overflow/update, 1 x break

4.11 TIM2, TIM3 - 16-bit general purpose timers

- 16-bit autoreload (AR) up-counter
- 15-bit prescaler adjustable to fixed power of 2 ratios 1...32768
- Timers with 3 or 2 individually configurable capture/compare channels
- PWM mode
- Interrupt sources: 2 or 3 x input capture/output compare, 1 x overflow/update

4.12 TIM4 - 8-bit basic timer

- 8-bit autoreload, adjustable prescaler ratio to any power of 2 from 1 to 128
- Clock source: CPU clock
- Interrupt source: 1 x overflow/update

Table 4. TIM timer features

| Timer | Counter size (bits) | Prescaler | Counting mode | CAPCOM channels | Complem. outputs | Ext. trigger | Timer synchron-ization/ chaining |
|-------|---------------------|--------------------------------|---------------|-----------------|------------------|--------------|----------------------------------|
| TIM1 | 16 | Any integer from 1 to 65536 | Up/down | 4 | 3 | Yes | No |
| TIM2 | 16 | Any power of 2 from 1 to 32768 | Up | 3 | 0 | No | |
| TIM3 | 16 | Any power of 2 from 1 to 32768 | Up | 2 | 0 | No | |
| TIM4 | 8 | Any power of 2 from 1 to 128 | Up | 0 | 0 | No | |

4.13 Analog-to-digital converter (ADC2)

STM8S20xxx performance line products contain a 10-bit successive approximation A/D converter (ADC2) with up to 16 multiplexed input channels and the following main features:

- Input voltage range: 0 to V_{DDA}
- Dedicated voltage reference (VREF) pins available on 80 and 64-pin devices
- Conversion time: 14 clock cycles
- Single and continuous modes
- External trigger input
- Trigger from TIM1 TRGO
- End of conversion (EOC) interrupt

4.14 Communication interfaces

The following communication interfaces are implemented:

- UART1: Full feature UART, SPI emulation, LIN2.1 master capability, Smartcard mode, IrDA mode, single wire mode.
- UART3: Full feature UART, LIN2.1 master/slave capability
- SPI: Full and half-duplex, 10 Mbit/s
- I²C: Up to 400 Kbit/s
- beCAN (rev. 2.0A,B) - 3 Tx mailboxes - up to 1 Mbit/s

4.14.1 UART1

Main features

- One Mbit/s full duplex SCI
- SPI emulation
- High precision baud rate generator
- Smartcard emulation
- IrDA SIR encoder decoder
- LIN master mode
- Single wire half duplex mode

Asynchronous communication (UART mode)

- Full duplex communication - NRZ standard format (mark/space)
- Programmable transmit and receive baud rates up to 1 Mbit/s ($f_{CPU}/16$) and capable of following any standard baud rate regardless of the input frequency
- Separate enable bits for transmitter and receiver
- Two receiver wakeup modes:
 - Address bit (MSB)
 - Idle line (interrupt)
- Transmission error detection with interrupt generation
- Parity control

Synchronous communication

- Full duplex synchronous transfers
- SPI master operation
- 8-bit data communication
- Maximum speed: 1 Mbit/s at 16 MHz ($f_{CPU}/16$)

LIN master mode

- Emission: Generates 13-bit sync break frame
- Reception: Detects 11-bit break frame

4.14.2 UART3

Main features

- 1 Mbit/s full duplex SCI
- LIN master capable
- High precision baud rate generator

تهیه و توزیع قطعات الکترونیک

Asynchronous communication (UART mode)

- Full duplex communication - NRZ standard format (mark/space)
- Programmable transmit and receive baud rates up to 1 Mbit/s ($f_{CPU}/16$) and capable of following any standard baud rate regardless of the input frequency
- Separate enable bits for transmitter and receiver
- Two receiver wakeup modes:
 - Address bit (MSB)
 - Idle line (interrupt)
- Transmission error detection with interrupt generation
- Parity control

LIN master capability

- Emission: Generates 13-bit sync break frame
- Reception: Detects 11-bit break frame

LIN slave mode

- Autonomous header handling - one single interrupt per valid message header
- Automatic baud rate synchronization - maximum tolerated initial clock deviation $\pm 15\%$
- Sync delimiter checking
- 11-bit LIN sync break detection - break detection always active
- Parity check on the LIN identifier field
- LIN error management
- Hot plugging support

4.14.3 SPI

- Maximum speed: 10 Mbit/s ($f_{MASTER}/2$) both for master and slave
- Full duplex synchronous transfers
- Simplex synchronous transfers on two lines with a possible bidirectional data line
- Master or slave operation - selectable by hardware or software
- CRC calculation
- 1 byte Tx and Rx buffer
- Slave/master selection input pin

The logo for SKYTECH, featuring the word "SKYTECH" in a bold, stylized, sans-serif font. The letters are white with a purple outline, set against a background of a large, faint, purple geometric shape that resembles a stylized 'S' or a similar symbol.

تهیه و توزیع قطعات الکترونیک

4.14.4 I²C

- I²C master features:
 - Clock generation
 - Start and stop generation
- I²C slave features:
 - Programmable I²C address detection
 - Stop bit detection
- Generation and detection of 7-bit/10-bit addressing and general call
- Supports different communication speeds:
 - Standard speed (up to 100 kHz)
 - Fast speed (up to 400 kHz)

4.14.5 beCAN

The beCAN controller (basic enhanced CAN), interfaces the CAN network and supports the CAN protocol version 2.0A and B. It has been designed to manage a high number of incoming messages efficiently with a minimum CPU load.

For safety-critical applications the beCAN controller provides all hardware functions to support the CAN time triggered communication option (TTCAN).

The maximum transmission speed is 1 Mbit.

Transmission

- Three transmit mailboxes
- Configurable transmit priority by identifier or order request
- Time stamp on SOF transmission

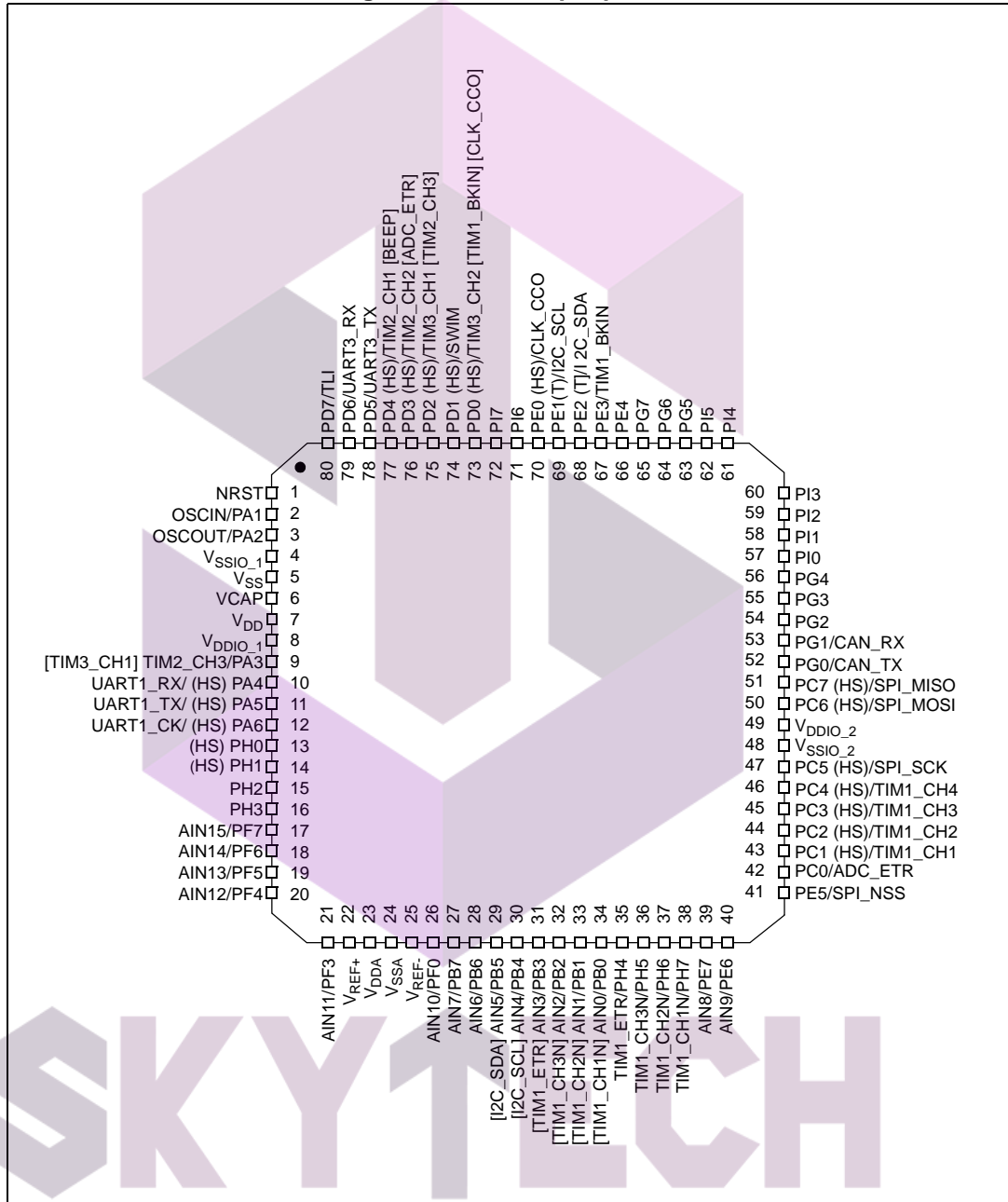
Reception

- 8-, 11- and 29-bit ID
- One receive FIFO (3 messages deep)
- Software-efficient mailbox mapping at a unique address space
- FMI (filter match index) stored with message
- Configurable FIFO overrun
- Time stamp on SOF reception
- Six filter banks, 2 x 32 bytes (scalable to 4 x 16-bit) each, enabling various masking configurations, such as 12 filters for 29-bit ID or 48 filters for 11-bit ID
- Filtering modes:
 - Mask mode permitting ID range filtering
 - ID list mode
- Time triggered communication option
 - Disable automatic retransmission mode
 - 16-bit free running timer
 - Configurable timer resolution
 - Time stamp sent in last two data bytes

5 Pinouts and pin description

5.1 Package pinouts

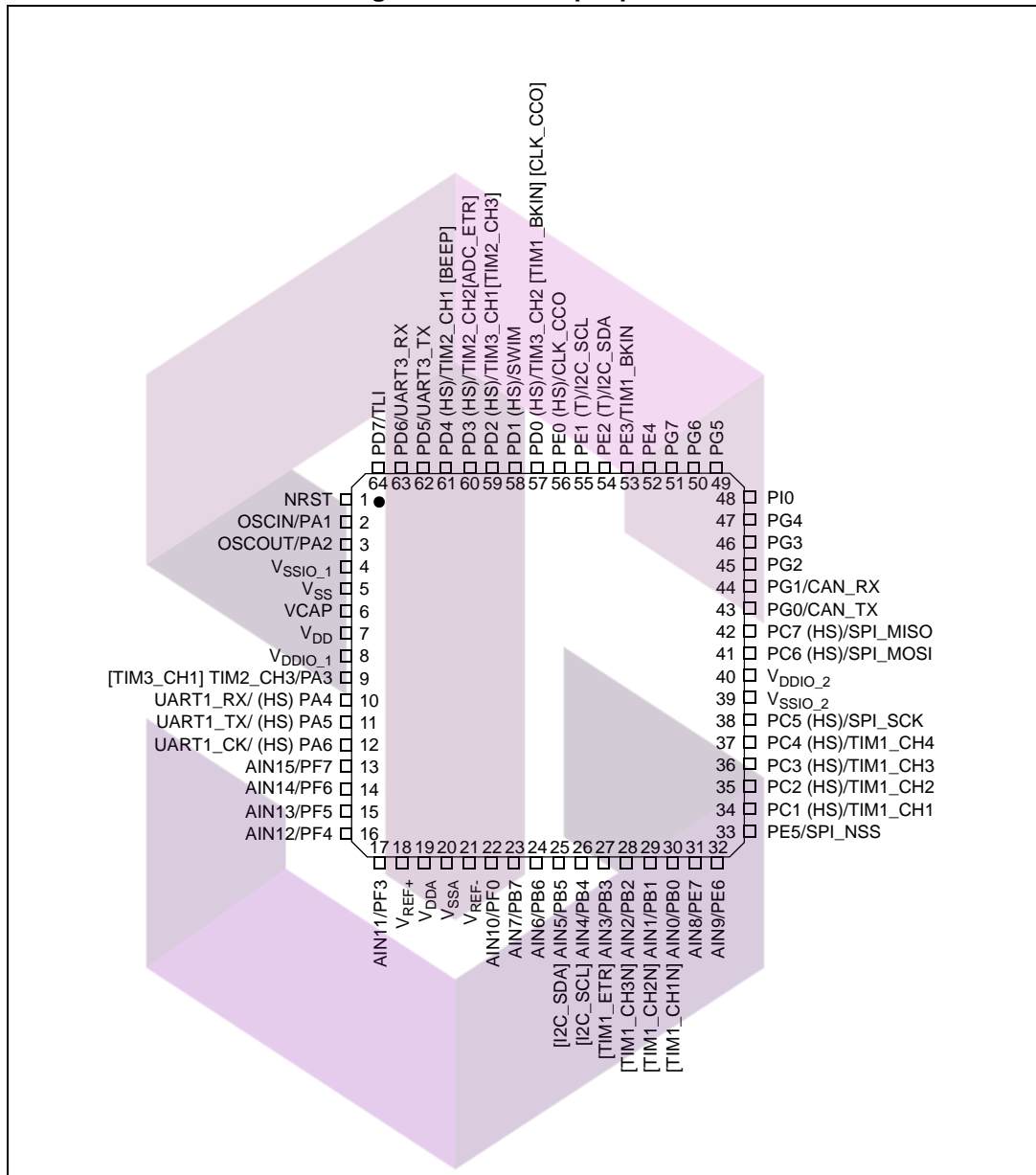
Figure 3. LQFP 80-pin pinout



1. (HS) high sink capability.
2. (T) True open drain (P-buffer and protection diode to V_{DD} not implemented).
3. [] alternate function remapping option (If the same alternate function is shown twice, it indicates an exclusive choice not a duplication of the function).
4. CAN_RX and CAN_TX is available on STM8S208xx devices only.



Figure 4. LQFP 64-pin pinout

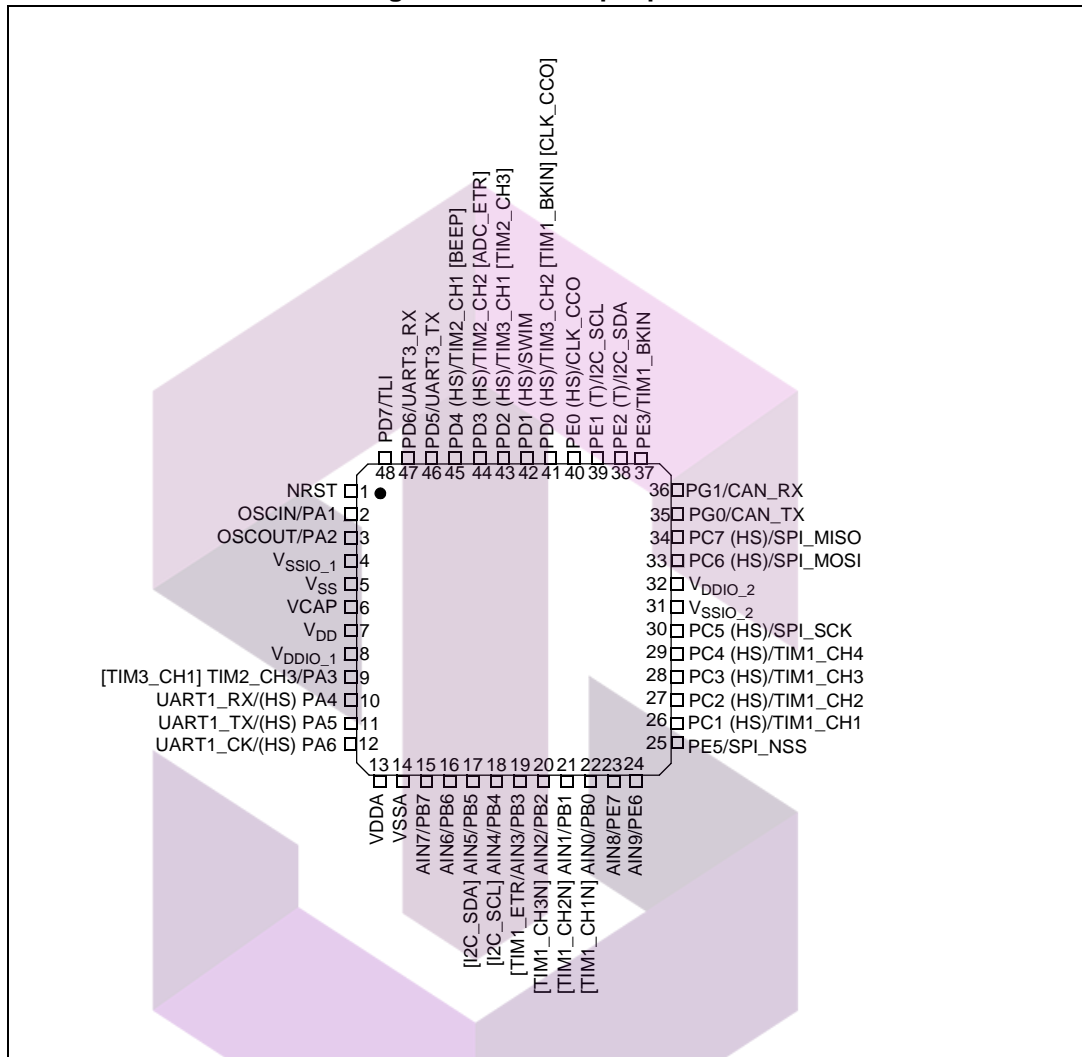


1. (HS) high sink capability.
2. (T) True open drain (P-buffer and protection diode to V_{DD} not implemented).
3. [] alternate function remapping option (If the same alternate function is shown twice, it indicates an exclusive choice not a duplication of the function).
4. CAN_RX and CAN_TX is available on STM8S208xx devices only.

SKYTECH

تهیه و توزیع قطعات الکترونیک

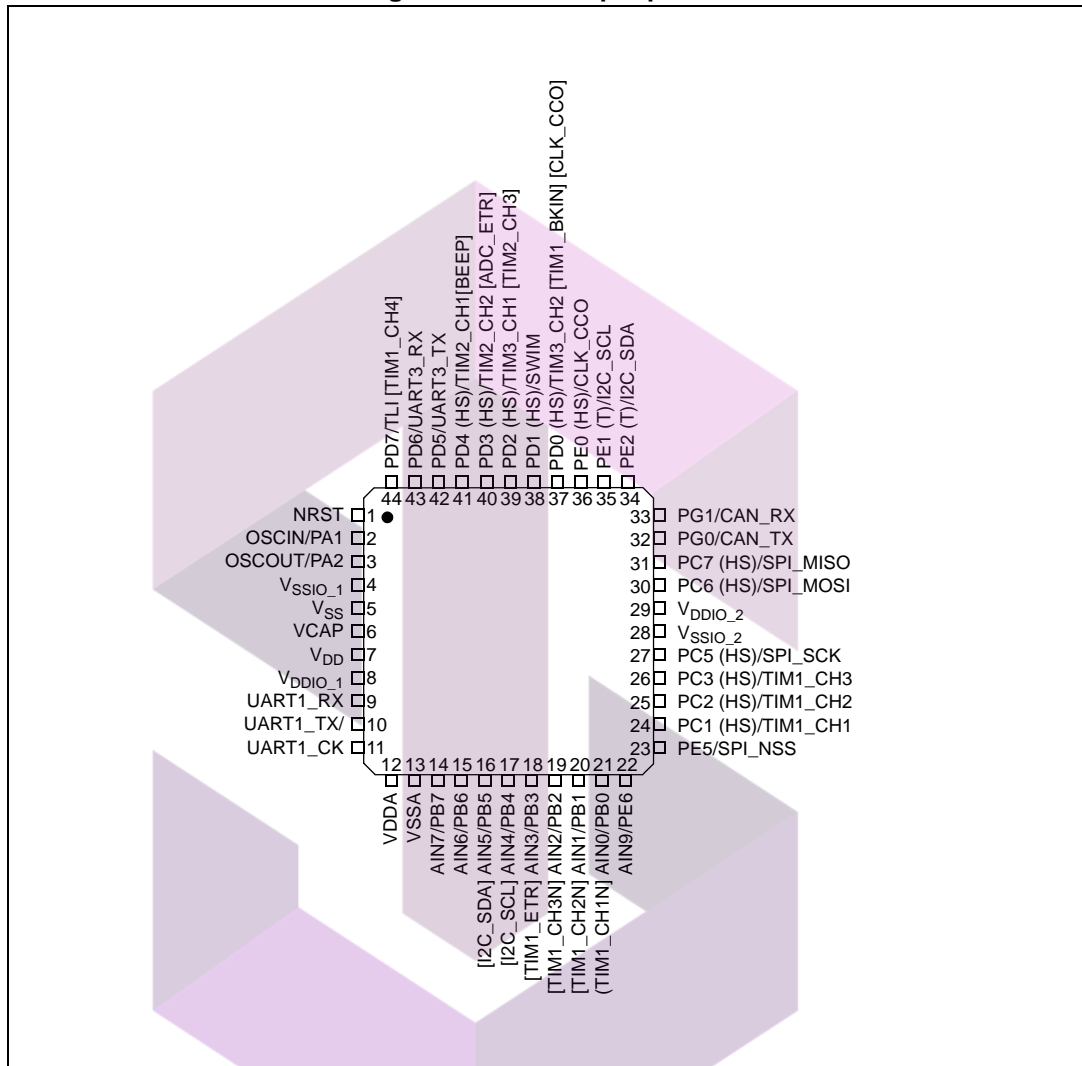
Figure 5. LQFP 48-pin pinout



1. (HS) high sink capability.
2. (T) True open drain (P-buffer and protection diode to V_{DD} not implemented).
3. [] alternate function remapping option (If the same alternate function is shown twice, it indicates an exclusive choice not a duplication of the function).
4. CAN_RX and CAN_TX is available on STM8S208xx devices only.



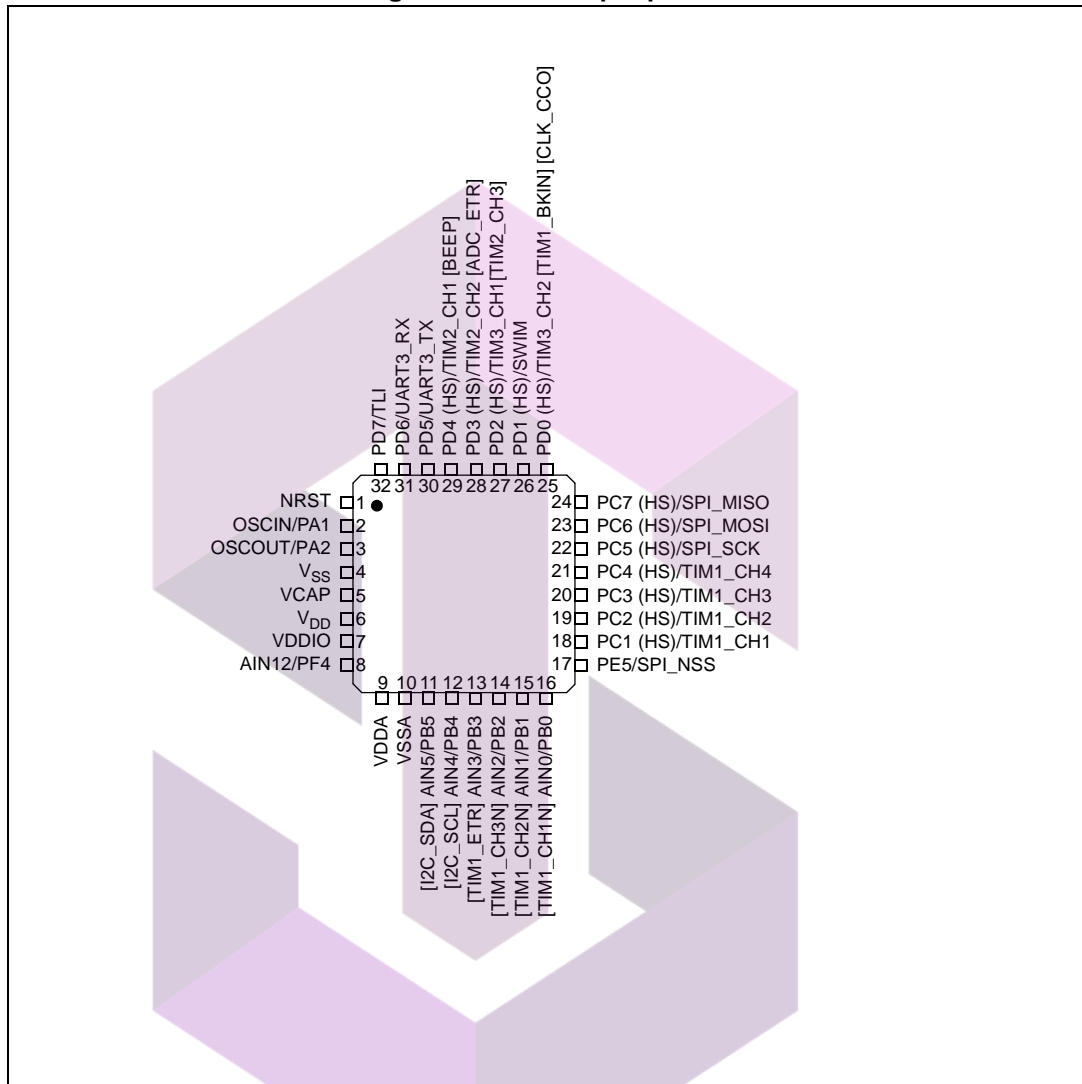
Figure 6. LQFP 44-pin pinout



1. (HS) high sink capability.
2. (T) True open drain (P-buffer and protection diode to V_{DD} not implemented).
3. [] alternate function remapping option (If the same alternate function is shown twice, it indicates an exclusive choice not a duplication of the function).
4. CAN_RX and CAN_TX is available on STM8S208xx devices only.



Figure 7. LQFP 32-pin pinout



1. (HS) high sink capability.
2. [] alternate function remapping option (If the same alternate function is shown twice, it indicates an exclusive choice not a duplication of the function).

SKYTECH

تهیه و توزیع قطعات الکترونیک

Table 5. Legend/abbreviations for pinout table

| | | |
|---------------------------------------|---|--|
| Type | I= Input, O = Output, S = Power supply | |
| Level | Input | CM = CMOS |
| | Output | HS = High sink |
| Output speed | O1 = Slow (up to 2 MHz) O2 = Fast (up to 10 MHz) O3 = Fast/slow programmability with slow as default state after reset O4 = Fast/slow programmability with fast as default state after reset | |
| Port and control configuration | Input | float = floating, wpu = weak pull-up |
| | Output | T = True open drain, OD = Open drain, PP = Push pull |
| Reset state | Bold X (pin state after internal reset release) Unless otherwise specified, the pin state is the same during the reset phase and after the internal reset release. | |

Table 6. Pin description

| Pin number | | | | | Pin name | Type | Input | | | Output | | | Main function (after reset) | Default alternate function | Alternate function after remap [option bit] |
|------------|--------|--------|--------|--------|---------------------|------|----------|-----|----------------|-----------|-------|----|-----------------------------|----------------------------|---|
| LQFP80 | LQFP64 | LQFP48 | LQFP44 | LQFP32 | | | floating | wpu | Ext. interrupt | High sink | Speed | OD | | | |
| 1 | 1 | 1 | 1 | 1 | NRST | I/O | X | | | | | | Reset | | |
| 2 | 2 | 2 | 2 | 2 | PA1/OSCIN | I/O | X | X | | O1 | X | X | Port A1 | Resonator/crystal in | |
| 3 | 3 | 3 | 3 | 3 | PA2/OSCOU | I/O | X | X | X | O1 | X | X | Port A2 | Resonator/crystal out | |
| 4 | 4 | 4 | 4 | - | V _{SSIO_1} | S | | | | | | | I/O ground | | |
| 5 | 5 | 5 | 5 | 4 | V _{SS} | S | | | | | | | Digital ground | | |
| 6 | 6 | 6 | 6 | 5 | VCAP | S | | | | | | | 1.8 V regulator capacitor | | |
| 7 | 7 | 7 | 7 | 6 | V _{DD} | S | | | | | | | Digital power supply | | |
| 8 | 8 | 8 | 8 | 7 | V _{DDIO_1} | S | | | | | | | I/O power supply | | |
| 9 | 9 | 9 | - | - | PA3/TIM2_CH3 | I/O | X | X | X | O1 | X | X | Port A3 | Timer 2 - channel3 | TIM3_CH1 [AFR1] |
| 10 | 10 | 10 | 9 | - | PA4/UART1_RX (1) | I/O | X | X | X | HS | O3 | X | Port A4 | UART1 receive | |
| 11 | 11 | 11 | 10 | - | PA5/UART1_TX | I/O | X | X | X | HS | O3 | X | Port A5 | UART1 transmit | |

Table 6. Pin description (continued)

| Pin number | | | | | Pin name | Type | Input | | | Output | | | | Main function (after reset) | Default alternate function | Alternate function after remap [option bit] |
|------------|--------|--------|--------|--------|-------------------|------|----------|-----|----------------|-----------|-------|----|----|-----------------------------|--------------------------------|---|
| LQFP80 | LQFP64 | LQFP48 | LQFP44 | LQFP32 | | | floating | wpu | Ext. interrupt | High sink | Speed | OD | PP | | | |
| 12 | 12 | 12 | 11 | - | PA6/UART1_CK | I/O | X | X | X | HS | O3 | X | X | Port A6 | UART1 synchronous clock | |
| 13 | - | - | - | - | PH0 | I/O | X | X | | HS | O3 | X | X | Port H0 | | |
| 14 | - | - | - | - | PH1 | I/O | X | X | | HS | O3 | X | X | Port H1 | | |
| 15 | - | - | - | - | PH2 | I/O | X | X | | O1 | X | X | | Port H2 | | |
| 16 | - | - | - | - | PH3 | I/O | X | X | | O1 | X | X | | Port H3 | | |
| 17 | 13 | - | - | - | PF7/AIN15 | I/O | X | X | | O1 | X | X | | Port F7 | Analog input 15 | |
| 18 | 14 | - | - | - | PF6/AIN14 | I/O | X | X | | O1 | X | X | | Port F6 | Analog input 14 | |
| 19 | 15 | - | - | - | PF5/AIN13 | I/O | X | X | | O1 | X | X | | Port F5 | Analog input 13 | |
| 20 | 16 | - | - | 8 | PF4/AIN12 | I/O | X | X | | O1 | X | X | | Port F4 | Analog input 12 | |
| 21 | 17 | - | - | - | PF3/AIN11 | I/O | X | X | | O1 | X | X | | Port F3 | Analog input 11 | |
| 22 | 18 | - | - | - | V _{REF+} | S | | | | | | | | | ADC positive reference voltage | |
| 23 | 19 | 13 | 12 | 9 | V _{DDA} | S | | | | | | | | | Analog power supply | |
| 24 | 20 | 14 | 13 | 10 | V _{SSA} | S | | | | | | | | | Analog ground | |
| 25 | 21 | - | - | - | V _{REF-} | S | | | | | | | | | ADC negative reference voltage | |
| 26 | 22 | - | - | - | PF0/AIN10 | I/O | X | X | | O1 | X | X | | Port F0 | Analog input 10 | |
| 27 | 23 | 15 | 14 | - | PB7/AIN7 | I/O | X | X | X | O1 | X | X | | Port B7 | Analog input 7 | |
| 28 | 24 | 16 | 15 | - | PB6/AIN6 | I/O | X | X | X | O1 | X | X | | Port B6 | Analog input 6 | |
| 29 | 25 | 17 | 16 | 11 | PB5/AIN5 | I/O | X | X | X | O1 | X | X | | Port B5 | Analog input 5 | I ² C_SDA [AFR6] |
| 30 | 26 | 18 | 17 | 12 | PB4/AIN4 | I/O | X | X | X | O1 | X | X | | Port B4 | Analog input 4 | I ² C_SCL [AFR6] |

Table 6. Pin description (continued)

| Pin number | | | | | Pin name | Type | Input | | | Output | | | | Main function (after reset) | Default alternate function | Alternate function after remap [option bit] |
|------------|--------|--------|--------|--------|----------------|------|----------|-----|----------------|-----------|-------|----|---------|------------------------------|----------------------------|---|
| LQFP80 | LQFP64 | LQFP48 | LQFP44 | LQFP32 | | | floating | wpu | Ext. interrupt | High sink | Speed | OD | PP | | | |
| 31 | 27 | 19 | 18 | 13 | PB3/AIN3 | I/O | X | X | X | O1 | X | X | Port B3 | Analog input 3 | TIM1_ETR [AFR5] | |
| 32 | 28 | 20 | 19 | 14 | PB2/AIN2 | I/O | X | X | X | O1 | X | X | Port B2 | Analog input 2 | TIM1_CH3N [AFR5] | |
| 33 | 29 | 21 | 20 | 15 | PB1/AIN1 | I/O | X | X | X | O1 | X | X | Port B1 | Analog input 1 | TIM1_CH2N [AFR5] | |
| 34 | 30 | 22 | 21 | 16 | PB0/AIN0 | I/O | X | X | X | O1 | X | X | Port B0 | Analog input 0 | TIM1_CH1N [AFR5] | |
| 35 | - | - | - | - | PH4/TIM1_ETR | I/O | X | X | | O1 | X | X | Port H4 | Timer 1 - trigger input | | |
| 36 | - | - | - | - | PH5/ TIM1_CH3N | I/O | X | X | | O1 | X | X | Port H5 | Timer 1 - inverted channel 3 | | |
| 37 | - | - | - | - | PH6/ TIM1_CH2N | I/O | X | X | | O1 | X | X | Port H6 | Timer 1 - inverted channel 2 | | |
| 38 | - | - | - | - | PH7/ TIM1_CH1N | I/O | X | X | | O1 | X | X | Port H7 | Timer 1 - inverted channel 2 | | |
| 39 | 31 | 23 | - | - | PE7/AIN8 | I/O | X | X | X | O1 | X | X | Port E7 | Analog input 8 | | |
| 40 | 32 | 24 | 22 | - | PE6/AIN9 | I/O | X | X | X | O1 | X | X | Port E6 | Analog input 9 | | |
| 41 | 33 | 25 | 23 | 17 | PE5/SPI_NSS | I/O | X | X | X | O1 | X | X | Port E5 | SPI master/slave select | | |
| 42 | - | - | - | - | PC0/ADC_ETR | I/O | X | X | X | O1 | X | X | Port C0 | ADC trigger input | | |
| 43 | 34 | 26 | 24 | 18 | PC1/TIM1_CH1 | I/O | X | X | X | HS O3 | X | X | Port C1 | Timer 1 - channel 1 | | |
| 44 | 35 | 27 | 25 | 19 | PC2/TIM1_CH2 | I/O | X | X | X | HS O3 | X | X | Port C2 | Timer 1 - channel 2 | | |
| 45 | 36 | 28 | 26 | 20 | PC3/TIM1_CH3 | I/O | X | X | X | HS O3 | X | X | Port C3 | Timer 1 - channel 3 | | |

Table 6. Pin description (continued)

| Pin number | | | | | Pin name | Type | Input | | | Output | | | Main function (after reset) | Default alternate function | Alternate function after remap [option bit] | |
|------------|--------|--------|--------|--------|---------------------------|------|----------|-----|----------------|-----------|-------|------------------|--------------------------------|----------------------------|---|----|
| LQFP80 | LQFP64 | LQFP48 | LQFP44 | LQFP32 | | | floating | wpu | Ext. interrupt | High sink | Speed | OD | | | | PP |
| 46 | 37 | 29 | - | 21 | PC4/TIM1_CH4 | I/O | X | X | X | HS | O3 | X | X | Port C4 | Timer 1 - channel 4 | |
| 47 | 38 | 30 | 27 | 22 | PC5/SPI_SCK | I/O | X | X | X | HS | O3 | X | X | Port C5 | SPI clock | |
| 48 | 39 | 31 | 28 | - | VSSIO_2 | S | | | | | | | | I/O ground | | |
| 49 | 40 | 32 | 29 | - | VDDIO_2 | S | | | | | | | | I/O power supply | | |
| 50 | 41 | 33 | 30 | 23 | PC6/SPI_MOSI | I/O | X | X | X | HS | O3 | X | X | Port C6 | SPI master out/ slave in | |
| 51 | 42 | 34 | 31 | 24 | PC7/SPI_MISO | I/O | X | X | X | HS | O3 | X | X | Port C7 | SPI master in/ slave out | |
| 52 | 43 | 35 | 32 | - | PG0/CAN_TX ⁽²⁾ | I/O | X | X | | | O1 | X | X | Port G0 | beCAN transmit | |
| 53 | 44 | 36 | 33 | - | PG1/CAN_RX ⁽²⁾ | I/O | X | X | | | O1 | X | X | Port G1 | beCAN receive | |
| 54 | 45 | - | - | - | PG2 | I/O | X | X | | | O1 | X | X | Port G2 | | |
| 55 | 46 | - | - | - | PG3 | I/O | X | X | | | O1 | X | X | Port G3 | | |
| 56 | 47 | - | - | - | PG4 | I/O | X | X | | | O1 | X | X | Port G4 | | |
| 57 | 48 | - | - | - | PI0 | I/O | X | X | | | O1 | X | X | Port I0 | | |
| 58 | - | - | - | - | PI1 | I/O | X | X | | | O1 | X | X | Port I1 | | |
| 59 | - | - | - | - | PI2 | I/O | X | X | | | O1 | X | X | Port I2 | | |
| 60 | - | - | - | - | PI3 | I/O | X | X | | | O1 | X | X | Port I3 | | |
| 61 | - | - | - | - | PI4 | I/O | X | X | | | O1 | X | X | Port I4 | | |
| 62 | - | - | - | - | PI5 | I/O | X | X | | | O1 | X | X | Port I5 | | |
| 63 | 49 | - | - | - | PG5 | I/O | X | X | | | O1 | X | X | Port G5 | | |
| 64 | 50 | - | - | - | PG6 | I/O | X | X | | | O1 | X | X | Port G6 | | |
| 65 | 51 | - | - | - | PG7 | I/O | X | X | | | O1 | X | X | Port G7 | | |
| 66 | 52 | - | - | - | PE4 | I/O | X | X | X | | O1 | X | X | Port E4 | | |
| 67 | 53 | 37 | - | - | PE3/TIM1_BKIN | I/O | X | X | X | | O1 | X | X | Port E3 | Timer 1 - break input | |
| 68 | 54 | 38 | 34 | - | PE2/I ² C_SDA | I/O | X | | X | | O1 | T ⁽³⁾ | | Port E2 | I ² C data | |

Table 6. Pin description (continued)

| Pin number | | | | | Pin name | Type | Input | | | Output | | | | Main function (after reset) | Default alternate function | Alternate function after remap [option bit] |
|------------|--------|--------|--------|--------|------------------------------|------|----------|-----|----------------|-----------|------------------|----|---------|-----------------------------|----------------------------|---|
| LQFP80 | LQFP64 | LQFP48 | LQFP44 | LQFP32 | | | floating | wpu | Ext. interrupt | High sink | Speed | OD | PP | | | |
| 69 | 55 | 39 | 35 | - | PE1/I ² C_SCL | I/O | X | | X | O1 | T ⁽³⁾ | | Port E1 | I ² C clock | | |
| 70 | 56 | 40 | 36 | - | PE0/CLK_CCO | I/O | X | X | X | HS | O3 | X | X | Port E0 | Configurable clock output | |
| 71 | - | - | - | - | PI6 | I/O | X | X | | | O1 | X | X | Port I6 | | |
| 72 | - | - | - | - | PI7 | I/O | X | X | | | O1 | X | X | Port I7 | | |
| 73 | 57 | 41 | 37 | 25 | PD0/TIM3_CH2 | I/O | X | X | X | HS | O3 | X | X | Port D0 | Timer 3 - channel 2 | TIM1_BKIN [AFR3]/CLK_CCO [AFR2] |
| 74 | 58 | 42 | 38 | 26 | PD1/SWIM ⁽⁴⁾ | I/O | X | X | X | HS | O4 | X | X | Port D1 | SWIM data interface | |
| 75 | 59 | 43 | 39 | 27 | PD2/TIM3_CH1 | I/O | X | X | X | HS | O3 | X | X | Port D2 | Timer 3 - channel 1 | TIM2_CH3 [AFR1] |
| 76 | 60 | 44 | 40 | 28 | PD3/TIM2_CH2 | I/O | X | X | X | HS | O3 | X | X | Port D3 | Timer 2 - channel 2 | ADC_ETR [AFR0] |
| 77 | 61 | 45 | 41 | 29 | PD4/TIM2_CH1/BEEP | I/O | X | X | X | HS | O3 | X | X | Port D4 | Timer 2 - channel 1 | BEEP output [AFR7] |
| 78 | 62 | 46 | 42 | 30 | PD5/ UART3_TX | I/O | X | X | X | | O1 | X | X | Port D5 | UART3 data transmit | |
| 79 | 63 | 47 | 43 | 31 | PD6/ UART3_RX ⁽¹⁾ | I/O | X | X | X | | O1 | X | X | Port D6 | UART3 data receive | |
| 80 | 64 | 48 | 44 | 32 | PD7/TLI | I/O | X | X | X | | O1 | X | X | Port D7 | Top level interrupt | TIM1_CH4 [AFR4] ⁽⁵⁾ |

1. The default state of UART1_RX and UART3_RX pins is controlled by the ROM bootloader. These pins are pulled up as part of the bootloader activation process and returned to the floating state before a return from the bootloader.
2. The beCAN interface is available on STM8S208xx devices only
3. In the open-drain output column, 'T' defines a true open-drain I/O (P-buffer, weak pull-up, and protection diode to V_{DD} are not implemented).
4. The PD1 pin is in input pull-up during the reset phase and after the internal reset release.
5. Available in 44-pin package only. On other packages, the AFR4 bit is reserved and must be kept at 0.

5.2 Alternate function remapping

As shown in the rightmost column of the pin description table, some alternate functions can be remapped at different I/O ports by programming one of eight AFR (alternate function

remap) option bits. Refer to [Section 8: Option bytes on page 47](#). When the remapping option is active, the default alternate function is no longer available.

To use an alternate function, the corresponding peripheral must be enabled in the peripheral registers.

Alternate function remapping does not effect GPIO capabilities of the I/O ports (see the GPIO section of the family reference manual, RM0016).



SKYTECH

تهیه و توزیع قطعات الکترونیک

6 Memory and register map

6.1 Memory map

Figure 8. Memory map

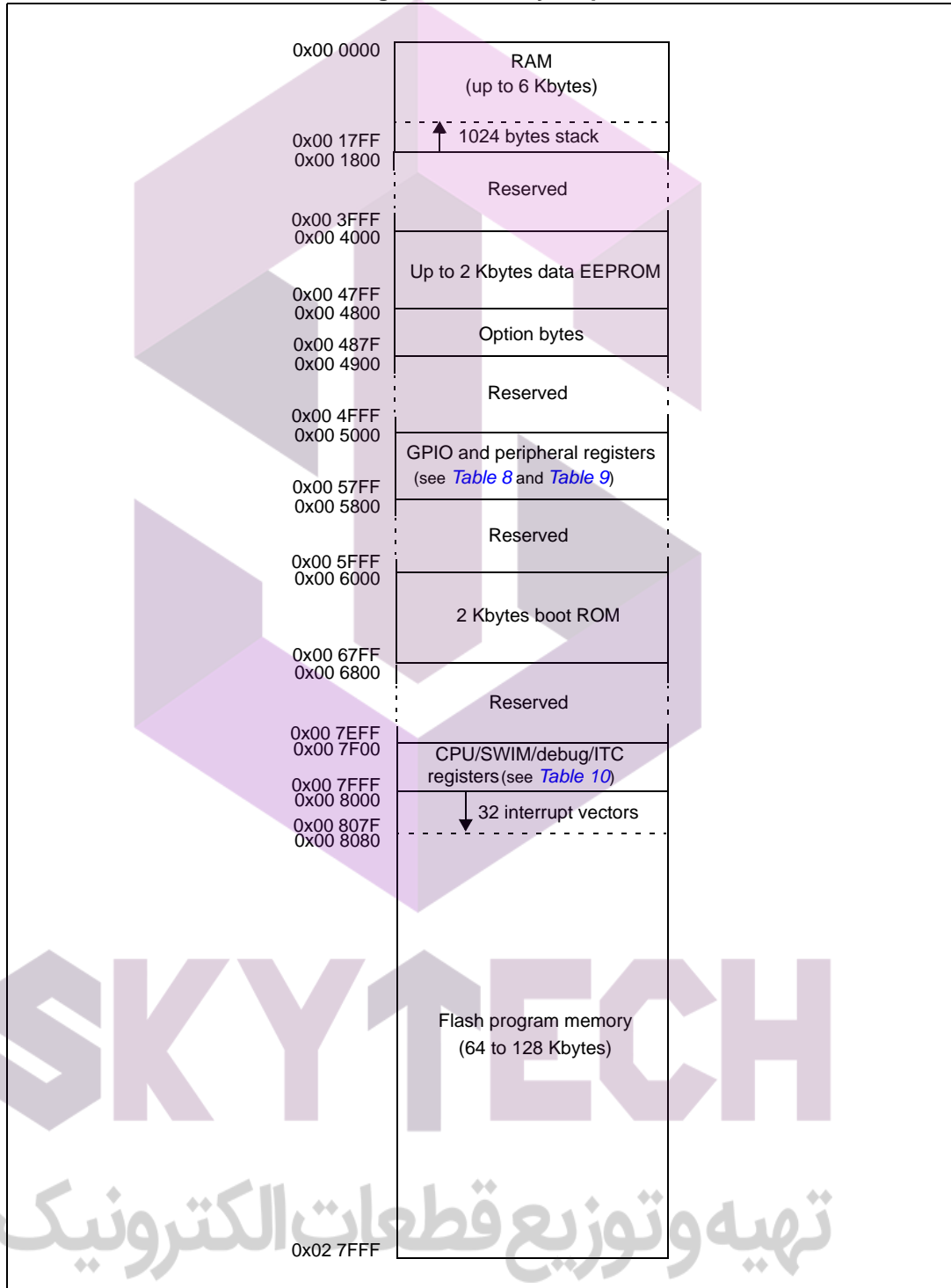


Table 7 lists the boundary addresses for each memory size. The top of the stack is at the RAM end address in each case.

Table 7. Flash, Data EEPROM and RAM boundary addresses

| Memory area | Size (bytes) | Start address | End address |
|----------------------|--------------|------------------|------------------|
| Flash program memory | 128 K | 0x00 8000 | 0x02 7FFF |
| | 64 K | 0x00 8000 | 0x01 7FFF |
| | 32 K | 0x00 8000 | 0x00 FFFF |
| RAM | 6 K | 0x00 0000 | 0x00 17FF |
| | 4 K | 0x00 0000 | 0x00 1000 |
| | 2 K | 0x00 0000 | 0x00 07FF |
| Data EEPROM | 2048 | 0x00 4000 | 0x00 47FF |
| | 1536 | 0x00 4000 | 0x00 45FF |
| | 1024 | 0x00 4000 | 0x00 43FF |

6.2 Register map

Table 8. I/O port hardware register map

| Address | Block | Register label | Register name | Reset status |
|-----------|--------|----------------|-----------------------------------|--------------|
| 0x00 5000 | Port A | PA_ODR | Port A data output latch register | 0x00 |
| 0x00 5001 | | PA_IDR | Port A input pin value register | 0x00 |
| 0x00 5002 | | PA_DDR | Port A data direction register | 0x00 |
| 0x00 5003 | | PA_CR1 | Port A control register 1 | 0x00 |
| 0x00 5004 | | PA_CR2 | Port A control register 2 | 0x00 |
| 0x00 5005 | Port B | PB_ODR | Port B data output latch register | 0x00 |
| 0x00 5006 | | PB_IDR | Port B input pin value register | 0x00 |
| 0x00 5007 | | PB_DDR | Port B data direction register | 0x00 |
| 0x00 5008 | | PB_CR1 | Port B control register 1 | 0x00 |
| 0x00 5009 | | PB_CR2 | Port B control register 2 | 0x00 |
| 0x00 500A | Port C | PC_ODR | Port C data output latch register | 0x00 |
| 0x00 500B | | PC_IDR | Port C input pin value register | 0x00 |
| 0x00 500C | | PC_DDR | Port C data direction register | 0x00 |
| 0x00 500D | | PC_CR1 | Port C control register 1 | 0x00 |
| 0x00 500E | | PC_CR2 | Port C control register 2 | 0x00 |

Table 8. I/O port hardware register map (continued)

| Address | Block | Register label | Register name | Reset status |
|-----------|--------|----------------|-----------------------------------|--------------|
| 0x00 500F | Port D | PD_ODR | Port D data output latch register | 0x00 |
| 0x00 5010 | | PD_IDR | Port D input pin value register | 0x00 |
| 0x00 5011 | | PD_DDR | Port D data direction register | 0x00 |
| 0x00 5012 | | PD_CR1 | Port D control register 1 | 0x02 |
| 0x00 5013 | | PD_CR2 | Port D control register 2 | 0x00 |
| 0x00 5014 | Port E | PE_ODR | Port E data output latch register | 0x00 |
| 0x00 5015 | | PE_IDR | Port E input pin value register | 0x00 |
| 0x00 5016 | | PE_DDR | Port E data direction register | 0x00 |
| 0x00 5017 | | PE_CR1 | Port E control register 1 | 0x00 |
| 0x00 5018 | | PE_CR2 | Port E control register 2 | 0x00 |
| 0x00 5019 | Port F | PF_ODR | Port F data output latch register | 0x00 |
| 0x00 501A | | PF_IDR | Port F input pin value register | 0x00 |
| 0x00 501B | | PF_DDR | Port F data direction register | 0x00 |
| 0x00 501C | | PF_CR1 | Port F control register 1 | 0x00 |
| 0x00 501D | | PF_CR2 | Port F control register 2 | 0x00 |
| 0x00 501E | Port G | PG_ODR | Port G data output latch register | 0x00 |
| 0x00 501F | | PG_IDR | Port G input pin value register | 0x00 |
| 0x00 5020 | | PG_DDR | Port G data direction register | 0x00 |
| 0x00 5021 | | PG_CR1 | Port G control register 1 | 0x00 |
| 0x00 5022 | | PG_CR2 | Port G control register 2 | 0x00 |
| 0x00 5023 | Port H | PH_ODR | Port H data output latch register | 0x00 |
| 0x00 5024 | | PH_IDR | Port H input pin value register | 0x00 |
| 0x00 5025 | | PH_DDR | Port H data direction register | 0x00 |
| 0x00 5026 | | PH_CR1 | Port H control register 1 | 0x00 |
| 0x00 5027 | | PH_CR2 | Port H control register 2 | 0x00 |
| 0x00 5028 | Port I | PI_ODR | Port I data output latch register | 0x00 |
| 0x00 5029 | | PI_IDR | Port I input pin value register | 0x00 |
| 0x00 502A | | PI_DDR | Port I data direction register | 0x00 |
| 0x00 502B | | PI_CR1 | Port I control register 1 | 0x00 |
| 0x00 502C | | PI_CR2 | Port I control register 2 | 0x00 |

تهیه و توزیع قطعات الکترونیک

Table 9. General hardware register map

| Address | Block | Register label | Register name | Reset status |
|------------------------|--------------------------|----------------|--|---------------------|
| 0x00 5050 to 0x00 5059 | Reserved area (10 bytes) | | | |
| 0x00 505A | Flash | FLASH_CR1 | Flash control register 1 | 0x00 |
| 0x00 505B | | FLASH_CR2 | Flash control register 2 | 0x00 |
| 0x00 505C | | FLASH_NCR2 | Flash complementary control register 2 | 0xFF |
| 0x00 505D | | FLASH_FPR | Flash protection register | 0x00 |
| 0x00 505E | | FLASH_NFPR | Flash complementary protection register | 0xFF |
| 0x00 505F | | FLASH_IAPSR | Flash in-application programming status register | 0x00 |
| 0x00 5060 to 0x00 5061 | Reserved area (2 bytes) | | | |
| 0x00 5062 | Flash | FLASH_PUKR | Flash Program memory unprotection register | 0x00 |
| 0x00 5063 | Reserved area (1 byte) | | | |
| 0x00 5064 | Flash | FLASH_DUKR | Data EEPROM unprotection register | 0x00 |
| 0x00 5065 to 0x00 509F | Reserved area (59 bytes) | | | |
| 0x00 50A0 | ITC | EXTI_CR1 | External interrupt control register 1 | 0x00 |
| 0x00 50A1 | | EXTI_CR2 | External interrupt control register 2 | 0x00 |
| 0x00 50A2 to 0x00 50B2 | Reserved area (17 bytes) | | | |
| 0x00 50B3 | RST | RST_SR | Reset status register | 0xFF ⁽¹⁾ |
| 0x00 50B4 to 0x00 50BF | Reserved area (12 bytes) | | | |
| 0x00 50C0 | CLK | CLK_ICKR | Internal clock control register | 0x01 |
| 0x00 50C1 | | CLK_ECKR | External clock control register | 0x00 |
| 0x00 50C2 | Reserved area (1 byte) | | | |
| 0x00 50C3 | CLK | CLK_CMSR | Clock master status register | 0xE1 |
| 0x00 50C4 | | CLK_SWR | Clock master switch register | 0xE1 |
| 0x00 50C5 | | CLK_SWCR | Clock switch control register | 0xFF |
| 0x00 50C6 | | CLK_CKDIVR | Clock divider register | 0x18 |
| 0x00 50C7 | | CLK_PCKENR1 | Peripheral clock gating register 1 | 0xFF |
| 0x00 50C8 | | CLK_CSSR | Clock security system register | 0x00 |
| 0x00 50C9 | | CLK_CCOR | Configurable clock control register | 0x00 |
| 0x00 50CA | | CLK_PCKENR2 | Peripheral clock gating register 2 | 0xFF |
| 0x00 50CB | | CLK_CANCCR | CAN clock control register | 0x00 |

Table 9. General hardware register map (continued)

| Address | Block | Register label | Register name | Reset status |
|---------------------------|--------------------------|----------------|--|---------------------|
| 0x00 50CC | CLK | CLK_HSITRIMR | HSI clock calibration trimming register | 0x00 |
| 0x00 50CD | | CLK_SWIMCCR | SWIM clock control register | 0bXXXX XXX0 |
| 0x00 50CE to 0x00 50D0 | Reserved area (3 bytes) | | | |
| 0x00 50D1 | WWDG | WWDG_CR | WWDG control register | 0x7F |
| 0x00 50D2 | | WWDG_WR | WWDR window register | 0x7F |
| 0x00 50D3 to 0x00 50DF | Reserved area (13 bytes) | | | |
| 0x00 50E0 | IWDG | IWDG_KR | IWDG key register | 0xXX ⁽²⁾ |
| 0x00 50E1 | | IWDG_PR | IWDG prescaler register | 0x00 |
| 0x00 50E2 | | IWDG_RLR | IWDG reload register | 0xFF |
| 0x00 50E3 to 0x00 50EF | Reserved area (13 bytes) | | | |
| 0x00 50F0 | AWU | AWU_CSR1 | AWU control/status register 1 | 0x00 |
| 0x00 50F1 | | AWU_APR | AWU asynchronous prescaler buffer register | 0x3F |
| 0x00 50F2 | | AWU_TBR | AWU timebase selection register | 0x00 |
| 0x00 50F3 | BEEP | BEEP_CSR | BEEP control/status register | 0x1F |
| 0x00 50F4 to 0x00 50FF | Reserved area (12 bytes) | | | |
| 0x00 5200 | SPI | SPI_CR1 | SPI control register 1 | 0x00 |
| 0x00 5201 | | SPI_CR2 | SPI control register 2 | 0x00 |
| 0x00 5202 | | SPI_ICR | SPI interrupt control register | 0x00 |
| 0x00 5203 | | SPI_SR | SPI status register | 0x02 |
| 0x00 5204 | | SPI_DR | SPI data register | 0x00 |
| 0x00 5205 | | SPI_CRCPR | SPI CRC polynomial register | 0x07 |
| 0x00 5206 | | SPI_RXCR | SPI Rx CRC register | 0xFF |
| 0x00 5207 | | SPI_TXCR | SPI Tx CRC register | 0xFF |
| 0x00 5208 to 0x00 520F | Reserved area (8 bytes) | | | |
| 0x00 5210 | I ² C | I2C_CR1 | I ² C control register 1 | 0x00 |
| 0x00 5211 | | I2C_CR2 | I ² C control register 2 | 0x00 |
| 0x00 5212 | | I2C_FREQR | I ² C frequency register | 0x00 |
| 0x00 5213 | | I2C_OARL | I ² C own address register low | 0x00 |
| 0x00 5214 | | I2C_OARH | I ² C own address register high | 0x00 |
| 0x00 5215 | | Reserved | | |

Table 9. General hardware register map (continued)

| Address | Block | Register label | Register name | Reset status |
|------------------------|--------------------------|--------------------------|--|--------------|
| 0x00 5216 | I ² C | I2C_DR | I ² C data register | 0x00 |
| 0x00 5217 | | I2C_SR1 | I ² C status register 1 | 0x00 |
| 0x00 5218 | | I2C_SR2 | I ² C status register 2 | 0x00 |
| 0x00 5219 | | I2C_SR3 | I ² C status register 3 | 0x00 |
| 0x00 521A | | I2C_ITR | I ² C interrupt control register | 0x00 |
| 0x00 521B | | I2C_CCRL | I ² C clock control register low | 0x00 |
| 0x00 521C | | I2C_CCRH | I ² C clock control register high | 0x00 |
| 0x00 521D | | I2C_TRISER | I ² C TRISE register | 0x02 |
| 0x00 521E to 0x00 522F | Reserved area (18 bytes) | | | |
| 0x00 5230 | UART1 | UART1_SR | UART1 status register | 0xC0 |
| 0x00 5231 | | UART1_DR | UART1 data register | 0xFF |
| 0x00 5232 | | UART1_BRR1 | UART1 baud rate register 1 | 0x00 |
| 0x00 5233 | | UART1_BRR2 | UART1 baud rate register 2 | 0x00 |
| 0x00 5234 | | UART1_CR1 | UART1 control register 1 | 0x00 |
| 0x00 5235 | | UART1_CR2 | UART1 control register 2 | 0x00 |
| 0x00 5236 | | UART1_CR3 | UART1 control register 3 | 0x00 |
| 0x00 5237 | | UART1_CR4 | UART1 control register 4 | 0x00 |
| 0x00 5238 | | UART1_CR5 | UART1 control register 5 | 0x00 |
| 0x00 5239 | | UART1_GTR | UART1 guard time register | 0x00 |
| 0x00 523A | | UART1_PSCR | UART1 prescaler register | 0x00 |
| 0x00 523B to 0x00 523F | Reserved area (5 bytes) | | | |
| 0x00 5240 | UART3 | UART3_SR | UART3 status register | C0h |
| 0x00 5241 | | UART3_DR | UART3 data register | 0xFF |
| 0x00 5242 | | UART3_BRR1 | UART3 baud rate register 1 | 0x00 |
| 0x00 5243 | | UART3_BRR2 | UART3 baud rate register 2 | 0x00 |
| 0x00 5244 | | UART3_CR1 | UART3 control register 1 | 0x00 |
| 0x00 5245 | | UART3_CR2 | UART3 control register 2 | 0x00 |
| 0x00 5246 | | UART3_CR3 | UART3 control register 3 | 0x00 |
| 0x00 5247 | | UART3_CR4 | UART3 control register 4 | 0x00 |
| 0x00 5248 | | Reserved | | |
| 0x00 5249 | UART3_CR6 | UART3 control register 6 | 0x00 | |
| 0x00 524A to 0x00 524F | Reserved area (6 bytes) | | | |

Table 9. General hardware register map (continued)

| Address | Block | Register label | Register name | Reset status |
|------------------------|-----------|---------------------------------|--|--------------|
| 0x00 5250 | TIM1 | TIM1_CR1 | TIM1 control register 1 | 0x00 |
| 0x00 5251 | | TIM1_CR2 | TIM1 control register 2 | 0x00 |
| 0x00 5252 | | TIM1_SMCR | TIM1 slave mode control register | 0x00 |
| 0x00 5253 | | TIM1_ETR | TIM1 external trigger register | 0x00 |
| 0x00 5254 | | TIM1_IER | TIM1 Interrupt enable register | 0x00 |
| 0x00 5255 | | TIM1_SR1 | TIM1 status register 1 | 0x00 |
| 0x00 5256 | | TIM1_SR2 | TIM1 status register 2 | 0x00 |
| 0x00 5257 | | TIM1_EGR | TIM1 event generation register | 0x00 |
| 0x00 5258 | | TIM1_CCMR1 | TIM1 capture/compare mode register 1 | 0x00 |
| 0x00 5259 | | TIM1_CCMR2 | TIM1 capture/compare mode register 2 | 0x00 |
| 0x00 525A | | TIM1_CCMR3 | TIM1 capture/compare mode register 3 | 0x00 |
| 0x00 525B | | TIM1_CCMR4 | TIM1 capture/compare mode register 4 | 0x00 |
| 0x00 525C | | TIM1_CCER1 | TIM1 capture/compare enable register 1 | 0x00 |
| 0x00 525D | | TIM1_CCER2 | TIM1 capture/compare enable register 2 | 0x00 |
| 0x00 525E | | TIM1_CNTRH | TIM1 counter high | 0x00 |
| 0x00 525F | | TIM1_CNTRL | TIM1 counter low | 0x00 |
| 0x00 5260 | | TIM1_PSCRH | TIM1 prescaler register high | 0x00 |
| 0x00 5261 | | TIM1_PSCRL | TIM1 prescaler register low | 0x00 |
| 0x00 5262 | | TIM1_ARRH | TIM1 auto-reload register high | 0xFF |
| 0x00 5263 | | TIM1_ARRL | TIM1 auto-reload register low | 0xFF |
| 0x00 5264 | | TIM1_RCR | TIM1 repetition counter register | 0x00 |
| 0x00 5265 | | TIM1_CCR1H | TIM1 capture/compare register 1 high | 0x00 |
| 0x00 5266 | | TIM1_CCR1L | TIM1 capture/compare register 1 low | 0x00 |
| 0x00 5267 | | TIM1_CCR2H | TIM1 capture/compare register 2 high | 0x00 |
| 0x00 5268 | | TIM1_CCR2L | TIM1 capture/compare register 2 low | 0x00 |
| 0x00 5269 | | TIM1_CCR3H | TIM1 capture/compare register 3 high | 0x00 |
| 0x00 526A | | TIM1_CCR3L | TIM1 capture/compare register 3 low | 0x00 |
| 0x00 526B | | TIM1_CCR4H | TIM1 capture/compare register 4 high | 0x00 |
| 0x00 526C | | TIM1_CCR4L | TIM1 capture/compare register 4 low | 0x00 |
| 0x00 526D | | TIM1_BKR | TIM1 break register | 0x00 |
| 0x00 526E | TIM1_DTR | TIM1 dead-time register | 0x00 | |
| 0x00 526F | TIM1_OISR | TIM1 output idle state register | 0x00 | |
| 0x00 5270 to 0x00 52FF | | Reserved area (147 bytes) | | |

Table 9. General hardware register map (continued)

| Address | Block | Register label | Register name | Reset status |
|------------------------|--------------------------|-------------------------------------|--|--------------|
| 0x00 5300 | TIM2 | TIM2_CR1 | TIM2 control register 1 | 0x00 |
| 0x00 5301 | | TIM2_IER | TIM2 interrupt enable register | 0x00 |
| 0x00 5302 | | TIM2_SR1 | TIM2 status register 1 | 0x00 |
| 0x00 5303 | | TIM2_SR2 | TIM2 status register 2 | 0x00 |
| 0x00 5304 | | TIM2_EGR | TIM2 event generation register | 0x00 |
| 0x00 5305 | | TIM2_CCMR1 | TIM2 capture/compare mode register 1 | 0x00 |
| 0x00 5306 | | TIM2_CCMR2 | TIM2 capture/compare mode register 2 | 0x00 |
| 0x00 5307 | | TIM2_CCMR3 | TIM2 capture/compare mode register 3 | 0x00 |
| 0x00 5308 | | TIM2_CCER1 | TIM2 capture/compare enable register 1 | 0x00 |
| 0x00 5309 | | TIM2_CCER2 | TIM2 capture/compare enable register 2 | 0x00 |
| 0x00 530A | | TIM2_CNTRH | TIM2 counter high | 0x00 |
| 0x00 530B | | TIM2_CNTRL | TIM2 counter low | 0x00 |
| 00 530C0x | | TIM2_PSCR | TIM2 prescaler register | 0x00 |
| 0x00 530D | | TIM2_ARRH | TIM2 auto-reload register high | 0xFF |
| 0x00 530E | | TIM2_ARRL | TIM2 auto-reload register low | 0xFF |
| 0x00 530F | | TIM2_CCR1H | TIM2 capture/compare register 1 high | 0x00 |
| 0x00 5310 | | TIM2_CCR1L | TIM2 capture/compare register 1 low | 0x00 |
| 0x00 5311 | | TIM2_CCR2H | TIM2 capture/compare reg. 2 high | 0x00 |
| 0x00 5312 | | TIM2_CCR2L | TIM2 capture/compare register 2 low | 0x00 |
| 0x00 5313 | | TIM2_CCR3H | TIM2 capture/compare register 3 high | 0x00 |
| 0x00 5314 | TIM2_CCR3L | TIM2 capture/compare register 3 low | 0x00 | |
| 0x00 5315 to 0x00 531F | Reserved area (11 bytes) | | | |
| 0x00 5320 | TIM3 | TIM3_CR1 | TIM3 control register 1 | 0x00 |
| 0x00 5321 | | TIM3_IER | TIM3 interrupt enable register | 0x00 |
| 0x00 5322 | | TIM3_SR1 | TIM3 status register 1 | 0x00 |
| 0x00 5323 | | TIM3_SR2 | TIM3 status register 2 | 0x00 |
| 0x00 5324 | | TIM3_EGR | TIM3 event generation register | 0x00 |
| 0x00 5325 | | TIM3_CCMR1 | TIM3 capture/compare mode register 1 | 0x00 |
| 0x00 5326 | | TIM3_CCMR2 | TIM3 capture/compare mode register 2 | 0x00 |
| 0x00 5327 | | TIM3_CCER1 | TIM3 capture/compare enable register 1 | 0x00 |
| 0x00 5328 | | TIM3_CNTRH | TIM3 counter high | 0x00 |
| 0x00 5329 | | TIM3_CNTRL | TIM3 counter low | 0x00 |
| 0x00 532A | | TIM3_PSCR | TIM3 prescaler register | 0x00 |

Table 9. General hardware register map (continued)

| Address | Block | Register label | Register name | Reset status |
|------------------------|---------------------------|--------------------------|---|--------------|
| 0x00 532B | TIM3 | TIM3_ARRH | TIM3 auto-reload register high | 0xFF |
| 0x00 532C | | TIM3_ARRL | TIM3 auto-reload register low | 0xFF |
| 0x00 532D | | TIM3_CCR1H | TIM3 capture/compare register 1 high | 0x00 |
| 0x00 532E | | TIM3_CCR1L | TIM3 capture/compare register 1 low | 0x00 |
| 0x00 532F | | TIM3_CCR2H | TIM3 capture/compare register 2 high | 0x00 |
| 0x00 5330 | | TIM3_CCR2L | TIM3 capture/compare register 2 low | 0x00 |
| 0x00 5331 to 0x00 533F | | Reserved area (15 bytes) | | |
| 0x00 5340 | TIM4 | TIM4_CR1 | TIM4 control register 1 | 0x00 |
| 0x00 5341 | | TIM4_IER | TIM4 interrupt enable register | 0x00 |
| 0x00 5342 | | TIM4_SR | TIM4 status register | 0x00 |
| 0x00 5343 | | TIM4_EGR | TIM4 event generation register | 0x00 |
| 0x00 5344 | | TIM4_CNTR | TIM4 counter | 0x00 |
| 0x00 5345 | | TIM4_PSCR | TIM4 prescaler register | 0x00 |
| 0x00 5346 | | TIM4_ARR | TIM4 auto-reload register | 0xFF |
| 0x00 5347 to 0x00 53FF | Reserved area (185 bytes) | | | |
| 0x00 5400 | ADC2 | ADC_CSR | ADC control/status register | 0x00 |
| 0x00 5401 | | ADC_CR1 | ADC configuration register 1 | 0x00 |
| 0x00 5402 | | ADC_CR2 | ADC configuration register 2 | 0x00 |
| 0x00 5403 | | ADC_CR3 | ADC configuration register 3 | 0x00 |
| 0x00 5404 | | ADC_DRH | ADC data register high | 0xFF |
| 0x00 5405 | | ADC_DRL | ADC data register low | 0xFF |
| 0x00 5406 | | ADC_TDRH | ADC Schmitt trigger disable register high | 0x00 |
| 0x00 5407 | | ADC_TDRL | ADC Schmitt trigger disable register low | 0x00 |
| 0x00 5408 to 0x00 541F | Reserved area (24 bytes) | | | |
| 0x00 5420 | beCAN | CAN_MCR | CAN master control register | 0x02 |
| 0x00 5421 | | CAN_MSR | CAN master status register | 0x02 |
| 0x00 5422 | | CAN_TSR | CAN transmit status register | 0x00 |
| 0x00 5423 | | CAN_TPR | CAN transmit priority register | 0x0C |
| 0x00 5424 | | CAN_RFR | CAN receive FIFO register | 0x00 |
| 0x00 5425 | | CAN_IER | CAN interrupt enable register | 0x00 |
| 0x00 5426 | | CAN_DGR | CAN diagnosis register | 0x0C |
| 0x00 5427 | | CAN_FPSR | CAN page selection register | 0x00 |

Table 9. General hardware register map (continued)

| Address | Block | Register label | Register name | Reset status |
|------------------------|---------------------------|----------------|----------------------|---------------------|
| 0x00 5428 | beCAN | CAN_P0 | CAN paged register 0 | 0xXX ⁽³⁾ |
| 0x00 5429 | | CAN_P1 | CAN paged register 1 | 0xXX ⁽³⁾ |
| 0x00 542A | | CAN_P2 | CAN paged register 2 | 0xXX ⁽³⁾ |
| 0x00 542B | | CAN_P3 | CAN paged register 3 | 0xXX ⁽³⁾ |
| 0x00 542C | | CAN_P4 | CAN paged register 4 | 0xXX ⁽³⁾ |
| 0x00 542D | | CAN_P5 | CAN paged register 5 | 0xXX ⁽³⁾ |
| 0x00 542E | | CAN_P6 | CAN paged register 6 | 0xXX ⁽³⁾ |
| 0x00 542F | | CAN_P7 | CAN paged register 7 | 0xXX ⁽³⁾ |
| 0x00 5430 | | CAN_P8 | CAN paged register 8 | 0xXX ⁽³⁾ |
| 0x00 5431 | | CAN_P9 | CAN paged register 9 | 0xXX ⁽³⁾ |
| 0x00 5432 | | CAN_PA | CAN paged register A | 0xXX ⁽³⁾ |
| 0x00 5433 | | CAN_PB | CAN paged register B | 0xXX ⁽³⁾ |
| 0x00 5434 | | CAN_PC | CAN paged register C | 0xXX ⁽³⁾ |
| 0x00 5435 | | CAN_PD | CAN paged register D | 0xXX ⁽³⁾ |
| 0x00 5436 | | CAN_PE | CAN paged register E | 0xXX ⁽³⁾ |
| 0x00 5437 | | CAN_PF | CAN paged register F | 0xXX ⁽³⁾ |
| 0x00 5438 to 0x00 57FF | Reserved area (968 bytes) | | | |

1. Depends on the previous reset source.
2. Write only register.
3. If the bootloader is enabled, it is initialized to 0x00.

SKYTECH

تهیه و توزیع قطعات الکترونیک

Table 10. CPU/SWIM/debug module/interrupt controller registers

| Address | Block | Register Label | Register Name | Reset Status | |
|------------------------|--------------------------|--------------------------|--|-------------------------------|------|
| 0x00 7F00 | CPU ⁽¹⁾ | A | Accumulator | 0x00 | |
| 0x00 7F01 | | PCE | Program counter extended | 0x00 | |
| 0x00 7F02 | | PCH | Program counter high | 0x00 | |
| 0x00 7F03 | | PCL | Program counter low | 0x00 | |
| 0x00 7F04 | | XH | X index register high | 0x00 | |
| 0x00 7F05 | | XL | X index register low | 0x00 | |
| 0x00 7F06 | | YH | Y index register high | 0x00 | |
| 0x00 7F07 | | YL | Y index register low | 0x00 | |
| 0x00 7F08 | | SPH | Stack pointer high | 0x17 ⁽²⁾ | |
| 0x00 7F09 | | SPL | Stack pointer low | 0xFF | |
| 0x00 7F0A | | CCR | Condition code register | 0x28 | |
| 0x00 7F0B to 0x00 7F5F | | Reserved area (85 bytes) | | | |
| 0x00 7F60 | | CPU | CFG_GCR | Global configuration register | 0x00 |
| 0x00 7F70 | ITC | ITC_SPR1 | Interrupt software priority register 1 | 0xFF | |
| 0x00 7F71 | | ITC_SPR2 | Interrupt software priority register 2 | 0xFF | |
| 0x00 7F72 | | ITC_SPR3 | Interrupt software priority register 3 | 0xFF | |
| 0x00 7F73 | | ITC_SPR4 | Interrupt software priority register 4 | 0xFF | |
| 0x00 7F74 | | ITC_SPR5 | Interrupt software priority register 5 | 0xFF | |
| 0x00 7F75 | | ITC_SPR6 | Interrupt software priority register 6 | 0xFF | |
| 0x00 7F76 | | ITC_SPR7 | Interrupt software priority register 7 | 0xFF | |
| 0x00 7F77 | | ITC_SPR8 | Interrupt software priority register 8 | 0xFF | |
| 0x00 7F78 to 0x00 7F79 | | Reserved area (2 bytes) | | | |
| 0x00 7F80 | SWIM | SWIM_CSR | SWIM control status register | 0x00 | |
| 0x00 7F81 to 0x00 7F8F | Reserved area (15 bytes) | | | | |
| 0x00 7F90 | DM | DM_BK1RE | DM breakpoint 1 register extended byte | 0xFF | |
| 0x00 7F91 | | DM_BK1RH | DM breakpoint 1 register high byte | 0xFF | |
| 0x00 7F92 | | DM_BK1RL | DM breakpoint 1 register low byte | 0xFF | |
| 0x00 7F93 | | DM_BK2RE | DM breakpoint 2 register extended byte | 0xFF | |
| 0x00 7F94 | | DM_BK2RH | DM breakpoint 2 register high byte | 0xFF | |
| 0x00 7F95 | | DM_BK2RL | DM breakpoint 2 register low byte | 0xFF | |
| 0x00 7F96 | | DM_CR1 | DM debug module control register 1 | 0x00 | |
| 0x00 7F97 | | DM_CR2 | DM debug module control register 2 | 0x00 | |

Table 10. CPU/SWIM/debug module/interrupt controller registers (continued)

| Address | Block | Register Label | Register Name | Reset Status |
|------------------------|-------------------------|----------------|---|--------------|
| 0x00 7F98 | DM | DM_CSR1 | DM debug module control/status register 1 | 0x10 |
| 0x00 7F99 | | DM_CSR2 | DM debug module control/status register 2 | 0x00 |
| 0x00 7F9A | | DM_ENFCTR | DM enable function register | 0xFF |
| 0x00 7F9B to 0x00 7F9F | Reserved area (5 bytes) | | | |

1. Accessible by debug module only
2. Product dependent value, see [Figure 8: Memory map](#).



SKYTECH

تهیه و توزیع قطعات الکترونیک

7 Interrupt vector mapping

Table 11. Interrupt mapping

| IRQ no. | Source block | Description | Wakeup from Halt mode | Wakeup from Active-halt mode | Vector address |
|----------|------------------|--|-----------------------|------------------------------|---------------------------|
| | RESET | Reset | Yes | Yes | 0x00 8000 |
| | TRAP | Software interrupt | - | - | 0x00 8004 |
| 0 | TLI | External top level interrupt | - | - | 0x00 8008 |
| 1 | AWU | Auto wake up from halt | - | Yes | 0x00 800C |
| 2 | CLK | Clock controller | - | - | 0x00 8010 |
| 3 | EXTI0 | Port A external interrupts | Yes ⁽¹⁾ | Yes ⁽¹⁾ | 0x00 8014 |
| 4 | EXTI1 | Port B external interrupts | Yes | Yes | 0x00 8018 |
| 5 | EXTI2 | Port C external interrupts | Yes | Yes | 0x00 801C |
| 6 | EXTI3 | Port D external interrupts | Yes | Yes | 0x00 8020 |
| 7 | EXTI4 | Port E external interrupts | Yes | Yes | 0x00 8024 |
| 8 | beCAN | beCAN RX interrupt | Yes | Yes | 0x00 8028 |
| 9 | beCAN | beCAN TX/ER/SC interrupt | - | - | 0x00 802C |
| 10 | SPI | End of transfer | Yes | Yes | 0x00 8030 |
| 11 | TIM1 | TIM1 update/overflow/underflow/ trigger/break | - | - | 0x00 8034 |
| 12 | TIM1 | TIM1 capture/compare | - | - | 0x00 8038 |
| 13 | TIM2 | TIM2 update /overflow | - | - | 0x00 803C |
| 14 | TIM2 | TIM2 capture/compare | - | - | 0x00 8040 |
| 15 | TIM3 | Update/overflow | - | - | 0x00 8044 |
| 16 | TIM3 | Capture/compare | - | - | 0x00 8048 |
| 17 | UART1 | Tx complete | - | - | 0x00 804C |
| 18 | UART1 | Receive register DATA FULL | - | - | 0x00 8050 |
| 19 | I ² C | I ² C interrupt | Yes | Yes | 0x00 8054 |
| 20 | UART3 | Tx complete | - | - | 0x00 8058 |
| 21 | UART3 | Receive register DATA FULL | - | - | 0x00 805C |
| 22 | ADC2 | ADC2 end of conversion | - | - | 0x00 8060 |
| 23 | TIM4 | TIM4 update/overflow | - | - | 0x00 8064 |
| 24 | Flash | EOP/WR_PG_DIS | - | - | 0x00 8068 |
| Reserved | | | | | 0x00 806C to 0x00 807C |

1. Except PA1



8 Option bytes

Option bytes contain configurations for device hardware features as well as the memory protection of the device. They are stored in a dedicated block of the memory. Except for the ROP (read-out protection) byte, each option byte has to be stored twice, in a regular form (OPTx) and a complemented one (NOPTx) for redundancy.

Option bytes can be modified in ICP mode (via SWIM) by accessing the EEPROM address shown in [Table 12: Option bytes](#) below. Option bytes can also be modified 'on the fly' by the application in IAP mode, except the ROP option that can only be modified in ICP mode (via SWIM).

Refer to the STM8S Flash programming manual (PM0051) and STM8 SWIM communication protocol and debug module user manual (UM0470) for information on SWIM programming procedures.

Table 12. Option bytes

| Addr. | Option name | Option byte no. | Option bits | | | | | | | | Factory default setting |
|-------|------------------------------------|-----------------|--------------|-------|-------|-------|----------|------------|----------|-------------|-------------------------|
| | | | 7 | 6 | 5 | 4 | 3 | 2 | 1 | 0 | |
| 4800h | Read-out protection (ROP) | OPT0 | ROP[7:0] | | | | | | | | 00h |
| 4801h | User boot code (UBC) | OPT1 | UBC[7:0] | | | | | | | | 00h |
| 4802h | | NOPT1 | NUBC[7:0] | | | | | | | | FFh |
| 4803h | Alternate function remapping (AFR) | OPT2 | AFR7 | AFR6 | AFR5 | AFR4 | AFR3 | AFR2 | AFR1 | AFR0 | 00h |
| 4804h | | NOPT2 | NAFR7 | NAFR6 | NAFR5 | NAFR4 | NAFR3 | NAFR2 | NAFR1 | NAFR0 | FFh |
| 4805h | Watchdog option | OPT3 | Reserved | | | | LSI_EN | IWDG_HW | WWDG_HW | WWDG_HALT | 00h |
| 4806h | | NOPT3 | Reserved | | | | NLSI_EN | NIWDG_HW | NWWDG_HW | NWWDG_HALT | FFh |
| 4807h | Clock option | OPT4 | Reserved | | | | EXT_CLK | CKAWU_SEL | PRSC1 | PRSC0 | 00h |
| 4808h | | NOPT4 | Reserved | | | | NEXT_CLK | NCKAWU_SEL | NPRSC1 | NPRSC0 | FFh |
| 4809h | HSE clock startup | OPT5 | HSECNT[7:0] | | | | | | | | 00h |
| 480Ah | | NOPT5 | NHSECNT[7:0] | | | | | | | | FFh |
| 480Bh | Reserved | OPT6 | Reserved | | | | | | | | 00h |
| 480Ch | | NOPT6 | Reserved | | | | | | | | FFh |
| 480Dh | Flash wait states | OPT7 | Reserved | | | | | | | Wait state | 00h |
| 480Eh | | NOPT7 | Reserved | | | | | | | Nwait state | FFh |
| 487Eh | Bootloader | OPTBL | BL[7:0] | | | | | | | | 00h |
| 487Fh | | NOPTBL | NBL[7:0] | | | | | | | | FFh |

تهیه و توزیع قطعات الکترونیک

Table 13. Option byte description

| Option byte no. | Description |
|-----------------|---|
| OPT0 | <p>ROP[7:0] <i>Memory readout protection (ROP)</i> 0xAA: Enable readout protection (write access via SWIM protocol) <i>Note: Refer to the family reference manual (RM0016) section on Flash/EEPROM memory readout protection for details.</i></p> |
| OPT1 | <p>UBC[7:0] <i>User boot code area</i> 0x00: no UBC, no write-protection 0x01: Pages 0 to 1 defined as UBC, memory write-protected 0x02: Pages 0 to 3 defined as UBC, memory write-protected 0x03: Pages 0 to 4 defined as UBC, memory write-protected ... 0xFE: Pages 0 to 255 defined as UBC, memory write-protected 0xFF: Reserved <i>Note: Refer to the family reference manual (RM0016) section on Flash/EEPROM write protection for more details.</i></p> |
| OPT2 | <p>AFR7 <i>Alternate function remapping option 7</i> 0: Port D4 alternate function = TIM2_CH1 1: Port D4 alternate function = BEEP</p> <p>AFR6 <i>Alternate function remapping option 6</i> 0: Port B5 alternate function = AIN5, port B4 alternate function = AIN4 1: Port B5 alternate function = I²C_SDA, port B4 alternate function = I²C_SCL</p> <p>AFR5 <i>Alternate function remapping option 5</i> 0: Port B3 alternate function = AIN3, port B2 alternate function = AIN2, port B1 alternate function = AIN1, port B0 alternate function = AIN0 1: Port B3 alternate function = TIM1_ETR, port B2 alternate function = TIM1_CH3N, port B1 alternate function = TIM1_CH2N, port B0 alternate function = TIM1_CH1N</p> <p>AFR4 <i>Alternate function remapping option 4</i> 0: Port D7 alternate function = TLI 1: Port D7 alternate function = TIM1_CH4</p> <p>AFR3 <i>Alternate function remapping option 3</i> 0: Port D0 alternate function = TIM3_CH2 1: Port D0 alternate function = TIM1_BKIN</p> <p>AFR2 <i>Alternate function remapping option 2</i> 0: Port D0 alternate function = TIM3_CH2 1: Port D0 alternate function = CLK_CCO <i>Note: AFR2 option has priority over AFR3 if both are activated</i></p> <p>AFR1 <i>Alternate function remapping option 1</i> 0: Port A3 alternate function = TIM2_CH3, port D2 alternate function = TIM3_CH1 1: Port A3 alternate function = TIM3_CH1, port D2 alternate function = TIM2_CH3</p> <p>AFR0 <i>Alternate function remapping option 0</i> 0: Port D3 alternate function = TIM2_CH2 1: Port D3 alternate function = ADC_ETR</p> |

تهیه و توزیع قطعات الکترونیک

Table 13. Option byte description (continued)

| Option byte no. | Description |
|-----------------|---|
| OPT3 | LSI_EN: <i>Low speed internal clock enable</i> 0: LSI clock is not available as CPU clock source 1: LSI clock is available as CPU clock source |
| | IWDG_HW: <i>Independent watchdog</i> 0: IWDG Independent watchdog activated by software 1: IWDG Independent watchdog activated by hardware |
| | WWDG_HW: <i>Window watchdog activation</i> 0: WWDG window watchdog activated by software 1: WWDG window watchdog activated by hardware |
| | WWDG_HALT: <i>Window watchdog reset on halt</i> 0: No reset generated on halt if WWDG active 1: Reset generated on halt if WWDG active |
| OPT4 | EXTCLK: <i>External clock selection</i> 0: External crystal connected to OSCIN/OSCOU 1: External clock signal on OSCIN |
| | CKAWUSEL: <i>Auto wakeup unit/clock</i> 0: LSI clock source selected for AWU 1: HSE clock with prescaler selected as clock source for AWU |
| | PRSC[1:0] AWU clock prescaler 00: 24 MHz to 128 kHz prescaler 01: 16 MHz to 128 kHz prescaler 10: 8 MHz to 128 kHz prescaler 11: 4 MHz to 128 kHz prescaler |
| OPT5 | HSECNT[7:0]: <i>HSE crystal oscillator stabilization time</i> This configures the stabilization time. 0x00: 2048 HSE cycles 0xB4: 128 HSE cycles 0xD2: 8 HSE cycles 0xE1: 0.5 HSE cycles |
| OPT6 | Reserved |
| OPT7 | WAITSTATE <i>Wait state configuration</i> This option configures the number of wait states inserted when reading from the Flash/data EEPROM memory. 1 wait state is required if $f_{CPU} > 16$ MHz. 0: No wait state 1: 1 wait state |

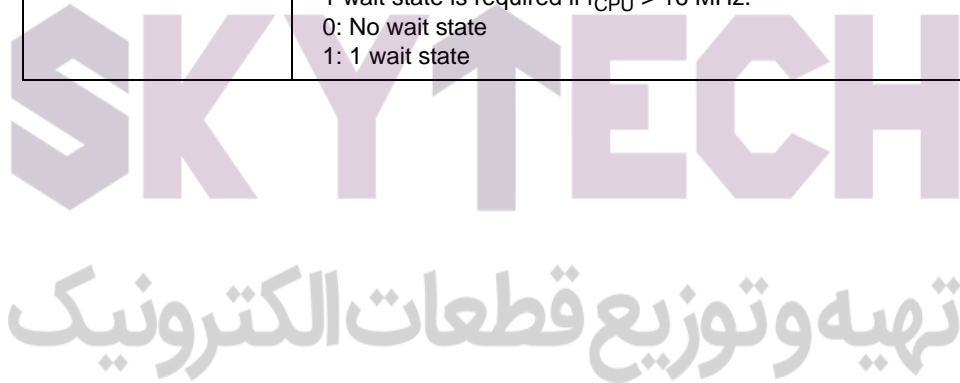


Table 13. Option byte description (continued)

| Option byte no. | Description |
|-----------------|---|
| OPTBL | <p>BL[7:0] <i>Bootloader option byte</i></p> <p>For STM8S products, this option is checked by the boot ROM code after reset. Depending on the content of addresses 0x487E, 0x487F, and 0x8000 (reset vector), the CPU jumps to the bootloader or to the reset vector. Refer to the UM0560 (STM8L/S bootloader manual) for more details.</p> <p>For STM8L products, the bootloader option bytes are on addresses 0XXXX and 0XXXX+1 (2 bytes). These option bytes control whether the bootloader is active or not. For more details, refer to the UM0560 (STM8L/S bootloader manual) for more details.</p> |


 The logo for SKYTECH, featuring the word "SKYTECH" in a bold, sans-serif font. The letter "Y" is stylized with an upward-pointing arrow. The logo is rendered in a light purple color.

تهیه و توزیع قطعات الکترونیک

9 Unique ID

The devices feature a 96-bit unique device identifier which provides a reference number that is unique for any device and in any context. The 96 bits of the identifier can never be altered by the user.

The unique device identifier can be read in single bytes and may then be concatenated using a custom algorithm.

The unique device identifier is ideally suited:

- For use as serial numbers
- For use as security keys to increase the code security in the program memory while using and combining this unique ID with software cryptographic primitives and protocols before programming the internal memory.
- To activate secure boot processes

Table 14. Unique ID registers (96 bits)

| Address | Content description | Unique ID bits | | | | | | | |
|---------|----------------------------|----------------|---|---|---|---|---|---|---|
| | | 7 | 6 | 5 | 4 | 3 | 2 | 1 | 0 |
| 0x48CD | X co-ordinate on the wafer | U_ID[7:0] | | | | | | | |
| 0x48CE | | U_ID[15:8] | | | | | | | |
| 0x48CF | Y co-ordinate on the wafer | U_ID[23:16] | | | | | | | |
| 0x48D0 | | U_ID[31:24] | | | | | | | |
| 0x48D1 | Lot number | U_ID[39:32] | | | | | | | |
| 0x48D2 | | U_ID[47:40] | | | | | | | |
| 0x48D3 | | U_ID[55:48] | | | | | | | |
| 0x48D4 | | U_ID[63:56] | | | | | | | |
| 0x48D5 | | U_ID[71:64] | | | | | | | |
| 0x48D6 | | U_ID[79:72] | | | | | | | |
| 0x48D7 | | U_ID[87:80] | | | | | | | |
| 0x48D8 | | U_ID[95:88] | | | | | | | |

SKYTECH

تهیه و توزیع قطعات الکترونیک

10 Electrical characteristics

10.1 Parameter conditions

Unless otherwise specified, all voltages are referred to V_{SS} .

10.1.1 Minimum and maximum values

Unless otherwise specified the minimum and maximum values are guaranteed in the worst conditions of ambient temperature, supply voltage and frequencies by tests in production on 100% of the devices with an ambient temperature at $T_A = 25\text{ °C}$ and $T_A = T_{Amax}$ (given by the selected temperature range).

Data based on characterization results, design simulation and/or technology characteristics are indicated in the table footnotes and are not tested in production. Based on characterization, the minimum and maximum values refer to sample tests and represent the mean value plus or minus three times the standard deviation (mean $\pm 3\sigma$).

10.1.2 Typical values

Unless otherwise specified, typical data are based on $T_A = 25\text{ °C}$, $V_{DD} = 5\text{ V}$. They are given only as design guidelines and are not tested.

Typical ADC accuracy values are determined by characterization of a batch of samples from a standard diffusion lot over the full temperature range, where 95% of the devices have an error less than or equal to the value indicated (mean $\pm 2\sigma$).

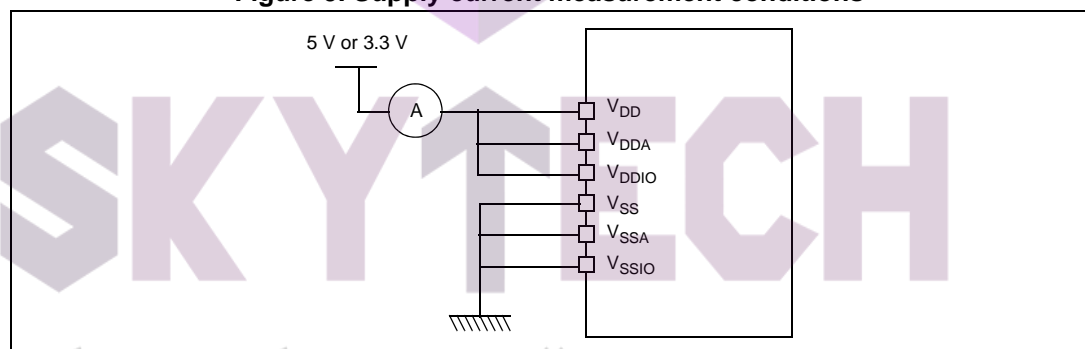
10.1.3 Typical curves

Unless otherwise specified, all typical curves are given only as design guidelines and are not tested.

10.1.4 Typical current consumption

For typical current consumption measurements, V_{DD} , V_{DDIO} and V_{DDA} are connected together in the configuration shown in [Figure 9](#).

Figure 9. Supply current measurement conditions



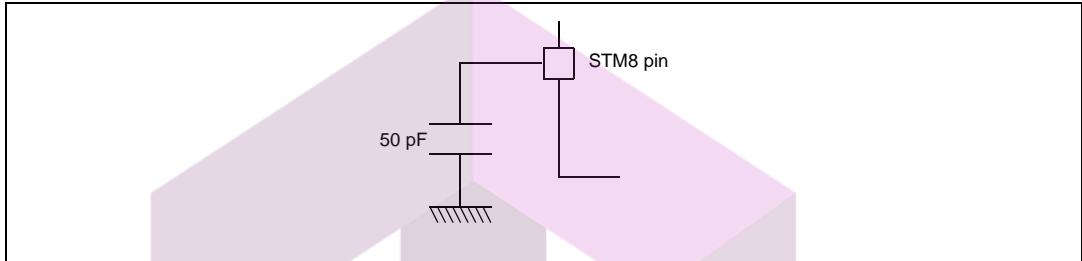
تهیه و توزیع قطعات الکترونیک

10.1.5 Pin loading conditions

10.1.6 Loading capacitor

The loading conditions used for pin parameter measurement are shown in [Figure 10](#).

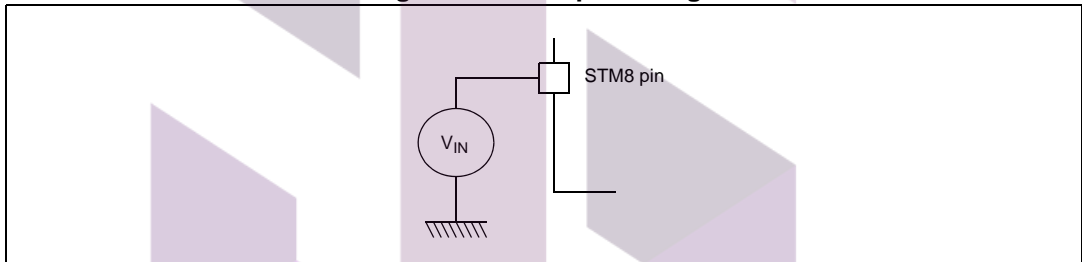
Figure 10. Pin loading conditions



10.1.7 Pin input voltage

The input voltage measurement on a pin of the device is described in [Figure 11](#).

Figure 11. Pin input voltage



SKYTECH

تهیه و توزیع قطعات الکترونیک

10.2 Absolute maximum ratings

Stresses above those listed as ‘absolute maximum ratings’ may cause permanent damage to the device. This is a stress rating only and functional operation of the device under these conditions is not implied. Exposure to maximum rating conditions for extended periods may affect device reliability.

Table 15. Voltage characteristics

| Symbol | Ratings | Min | Max | Unit |
|----------------------|---|---|----------------|------|
| $V_{DDx} - V_{SS}$ | Supply voltage (including V_{DDA} and V_{DDIO}) ⁽¹⁾ | -0.3 | 6.5 | V |
| V_{IN} | Input voltage on true open drain pins (PE1, PE2) ⁽²⁾ | $V_{SS} - 0.3$ | 6.5 | |
| | Input voltage on any other pin ⁽²⁾ | $V_{SS} - 0.3$ | $V_{DD} + 0.3$ | |
| $ V_{DDx} - V_{DD} $ | Variations between different power pins | | 50 | mV |
| $ V_{SSx} - V_{SS} $ | Variations between all the different ground pins | | 50 | |
| V_{ESD} | Electrostatic discharge voltage | see <i>Absolute maximum ratings (electrical sensitivity) on page 89</i> | | |

1. All power (V_{DD} , V_{DDIO} , V_{DDA}) and ground (V_{SS} , V_{SSIO} , V_{SSA}) pins must always be connected to the external power supply
2. $I_{INJ(PIN)}$ must never be exceeded. This is implicitly insured if V_{IN} maximum is respected. If V_{IN} maximum cannot be respected, the injection current must be limited externally to the $I_{INJ(PIN)}$ value. A positive injection is induced by $V_{IN} > V_{DD}$ while a negative injection is induced by $V_{IN} < V_{SS}$. For true open-drain pads, there is no positive injection current, and the corresponding V_{IN} maximum must always be respected

SKYTECH

تهيئه وتوزيع قطعات الكترونيك

Table 16. Current characteristics

| Symbol | Ratings | Max. ⁽¹⁾ | Unit |
|--------------------------------------|--|---------------------|------|
| I_{VDD} | Total current into V_{DD} power lines (source) ⁽²⁾ | 60 | mA |
| I_{VSS} | Total current out of V_{SS} ground lines (sink) ⁽²⁾ | 60 | |
| I_{IO} | Output current sunk by any I/O and control pin | 20 | |
| | Output current source by any I/Os and control pin | 20 | |
| ΣI_{IO} | Total output current sourced (sum of all I/O and control pins) for devices with two V_{DDIO} pins ⁽³⁾ | 200 | |
| | Total output current sourced (sum of all I/O and control pins) for devices with one V_{DDIO} pin ⁽³⁾ | 100 | |
| | Total output current sunk (sum of all I/O and control pins) for devices with two V_{SSIO} pins ⁽³⁾ | 160 | |
| | Total output current sunk (sum of all I/O and control pins) for devices with one V_{SSIO} pin ⁽³⁾ | 80 | |
| $I_{INJ(PIN)}$ ⁽⁴⁾⁽⁵⁾ | Injected current on NRST pin | ±4 | |
| | Injected current on OSCIN pin | ±4 | |
| | Injected current on any other pin ⁽⁶⁾ | ±4 | |
| $\Sigma I_{INJ(PIN)}$ ⁽⁴⁾ | Total injected current (sum of all I/O and control pins) ⁽⁶⁾ | ±20 | |

1. Data based on characterization results, not tested in production.
2. All power (V_{DD} , V_{DDIO} , V_{DDA}) and ground (V_{SS} , V_{SSIO} , V_{SSA}) pins must always be connected to the external supply.
3. I/O pins used simultaneously for high current source/sink must be uniformly spaced around the package between the V_{DDIO}/V_{SSIO} pins.
4. $I_{INJ(PIN)}$ must never be exceeded. This is implicitly insured if V_{IN} maximum is respected. If V_{IN} maximum cannot be respected, the injection current must be limited externally to the $I_{INJ(PIN)}$ value. A positive injection is induced by $V_{IN} > V_{DD}$ while a negative injection is induced by $V_{IN} < V_{SS}$. For true open-drain pads, there is no positive injection current, and the corresponding V_{IN} maximum must always be respected
5. Negative injection disturbs the analog performance of the device. See note in [Section 10.3.10: 10-bit ADC characteristics on page 85](#).
6. When several inputs are submitted to a current injection, the maximum $\Sigma I_{INJ(PIN)}$ is the absolute sum of the positive and negative injected currents (instantaneous values). These results are based on characterization with $\Sigma I_{INJ(PIN)}$ maximum current injection on four I/O port pins of the device.

Table 17. Thermal characteristics

| Symbol | Ratings | Value | Unit |
|-----------|------------------------------|------------|------|
| T_{STG} | Storage temperature range | -65 to 150 | °C |
| T_J | Maximum junction temperature | 150 | |

تهیه و توزیع قطعات الکترونیک

10.3 Operating conditions

The device must be used in operating conditions that respect the parameters in [Table 18](#). In addition, full account must be taken of all physical capacitor characteristics and tolerances.

Table 18. General operating conditions

| Symbol | Parameter | Conditions | Min | Max | Unit |
|-------------------------------------|--|---|------|--------------------|------|
| f _{CPU} | Internal CPU clock frequency | T _A ≤ 105 °C | 0 | 24 | MHz |
| | | | 0 | 16 | MHz |
| V _{DD} /V _{DD_IO} | Standard operating voltage | | 2.95 | 5.5 | V |
| V _{CAP} ⁽¹⁾ | C _{EXT} : capacitance of external capacitor | | 470 | 3300 | nF |
| | ESR of external capacitor | at 1 MHz ⁽²⁾ | - | 0.3 | Ω |
| | ESL of external capacitor | | - | 15 | nH |
| P _D ⁽³⁾ | Power dissipation at T _A = 85° C for suffix 6 or T _A = 125° C for suffix 3 | 44, 48, 64, and 80-pin devices, with output on 8 standard ports, 2 high sink ports and 2 open drain ports simultaneously ⁽⁴⁾ | | 443 | mW |
| | | 32-pin package, with output on 8 standard ports and 2 high sink ports simultaneously ⁽⁴⁾ | | 360 | |
| T _A | Ambient temperature for 6 suffix version | Maximum power dissipation | -40 | 85 | °C |
| | Ambient temperature for 3 suffix version | Maximum power dissipation | -40 | 125 | |
| T _J | Junction temperature range | 6 suffix version | -40 | 105 | |
| | | 3 suffix version | -40 | 130 ⁽⁵⁾ | |

- Care should be taken when selecting the capacitor, due to its tolerance, as well as the parameter dependency on temperature, DC bias and frequency in addition to other factors. The parameter maximum value must be respected for the full application range.
- This frequency of 1 MHz as a condition for V_{CAP} parameters is given by design of internal regulator.
- To calculate P_{Dmax}(T_A), use the formula $P_{Dmax} = (T_{Jmax} - T_A) / \Theta_{JA}$ (see [Section 11.2: Thermal characteristics on page 108](#)) with the value for T_{Jmax} given in [Table 18](#) above and the value for Θ_{JA} given in [Table 57: Thermal characteristics](#).
- Refer to [Section 11.2: Thermal characteristics on page 108](#) for the calculation method.
- T_{Jmax} is given by the test limit. Above this value the product behavior is not guaranteed.

SKYTECH

تهیه و توزیع قطعات الکترونیک

Figure 12. f_{CPUmax} versus V_{DD}

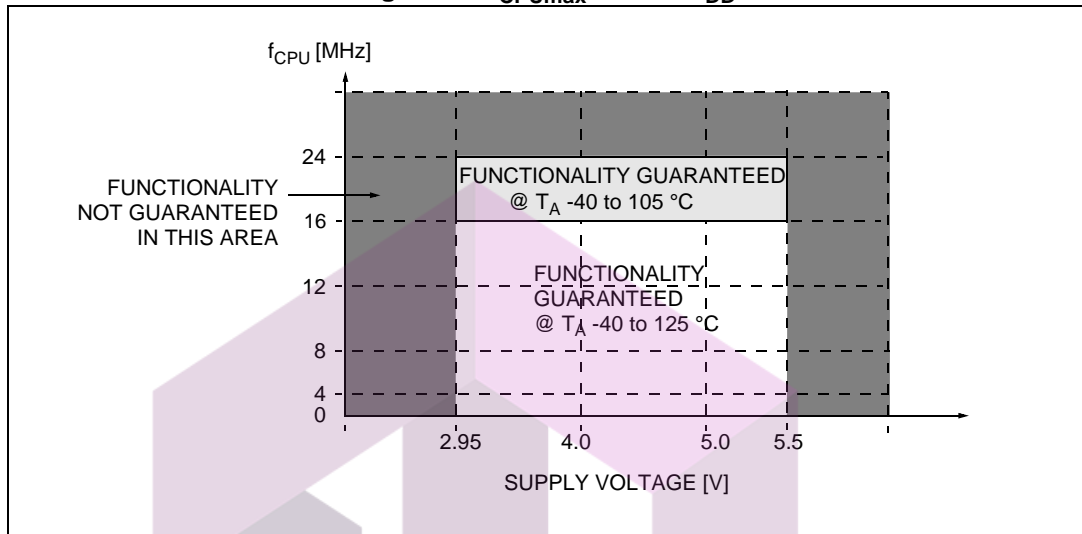


Table 19. Operating conditions at power-up/power-down

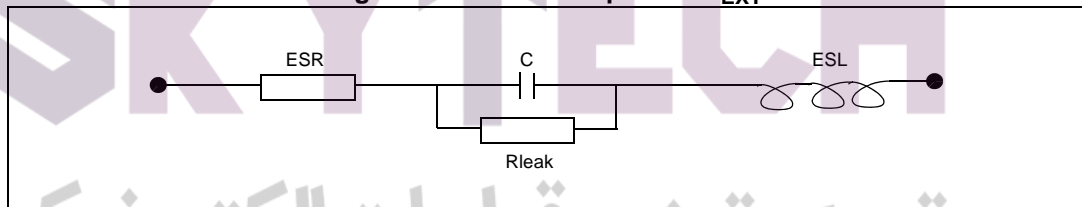
| Symbol | Parameter | Conditions | Min | Typ | Max | Unit |
|----------------|----------------------------|-----------------|------------------|------|--------------------|-----------------|
| t_{VDD} | V_{DD} rise time rate | | 2 ⁽¹⁾ | | ∞ | $\mu\text{s/V}$ |
| | V_{DD} fall time rate | | 2 ⁽¹⁾ | | ∞ | |
| t_{TEMP} | Reset release delay | V_{DD} rising | | | 1.7 ⁽¹⁾ | ms |
| V_{IT+} | Power-on reset threshold | | 2.65 | 2.8 | 2.95 | V |
| V_{IT-} | Brown-out reset threshold | | 2.58 | 2.73 | 2.88 | V |
| $V_{HYS(BOR)}$ | Brown-out reset hysteresis | | | 70 | | mV |

1. Guaranteed by design, not tested in production.

10.3.1 VCAP external capacitor

Stabilization for the main regulator is achieved connecting an external capacitor C_{EXT} to the V_{CAP} pin. C_{EXT} is specified in [Table 18](#). Care should be taken to limit the series inductance to less than 15 nH.

Figure 13. External capacitor C_{EXT}



1. Legend: ESR is the equivalent series resistance and ESL is the equivalent inductance.

10.3.2 Supply current characteristics

The current consumption is measured as described in [Figure 9 on page 52](#).

Total current consumption in run mode

The MCU is placed under the following conditions:

- All I/O pins in input mode with a static value at V_{DD} or V_{SS} (no load)
- All peripherals are disabled (clock stopped by Peripheral Clock Gating registers) except if explicitly mentioned.
- When the MCU is clocked at 24 MHz, $T_A \leq 105\text{ °C}$ and the WAITSTATE option bit is set.

Subject to general operating conditions for V_{DD} and T_A .

Table 20. Total current consumption with code execution in run mode at $V_{DD} = 5\text{ V}$

| Symbol | Parameter | Conditions | Typ | Max | Unit | |
|--|--|--|------------------------------|------|---------------------|----|
| I _{DD} (RUN) | Supply current in run mode, code executed from RAM | $f_{CPU} = f_{MASTER} = 24\text{ MHz}$, $T_A \leq 105\text{ °C}$ | HSE crystal osc. (24 MHz) | 4.4 | | mA |
| | | | HSE user ext. clock (24 MHz) | 3.7 | 7.3 ⁽¹⁾ | |
| | | $f_{CPU} = f_{MASTER} = 16\text{ MHz}$ | HSE crystal osc. (16 MHz) | 3.3 | | |
| | | | HSE user ext. clock (16 MHz) | 2.7 | 5.8 | |
| | | | HSI RC osc. (16 MHz) | 2.5 | 3.4 | |
| | | $f_{CPU} = f_{MASTER}/128 = 125\text{ kHz}$ | HSE user ext. clock (16 MHz) | 1.2 | 4.1 ⁽¹⁾ | |
| | | | HSI RC osc. (16 MHz) | 1.0 | 1.3 ⁽¹⁾ | |
| | $f_{CPU} = f_{MASTER}/128 = 15.625\text{ kHz}$ | HSI RC osc. (16 MHz/8) | 0.55 | | | |
| | $f_{CPU} = f_{MASTER} = 128\text{ kHz}$ | LSI RC osc. (128 kHz) | 0.45 | | | |
| | Supply current in run mode, code executed from Flash | $f_{CPU} = f_{MASTER} = 24\text{ MHz}$, $T_A \leq 105\text{ °C}$ | HSE crystal osc. (24 MHz) | 11.4 | | |
| | | | HSE user ext. clock (24 MHz) | 10.8 | 18 ⁽¹⁾ | |
| | | $f_{CPU} = f_{MASTER} = 16\text{ MHz}$ | HSE crystal osc. (16 MHz) | 9.0 | | |
| | | | HSE user ext. clock (16 MHz) | 8.2 | 15.2 ⁽¹⁾ | |
| | | | HSI RC osc. (16 MHz) | 8.1 | 13.2 ⁽¹⁾ | |
| $f_{CPU} = f_{MASTER} = 2\text{ MHz}$. | | HSI RC osc. (16 MHz/8) ⁽²⁾ | 1.5 | | | |
| $f_{CPU} = f_{MASTER}/128 = 125\text{ kHz}$ | | HSI RC osc. (16 MHz) | 1.1 | | | |
| $f_{CPU} = f_{MASTER}/128 = 15.625\text{ kHz}$ | HSI RC osc. (16 MHz/8) | 0.6 | | | | |
| $f_{CPU} = f_{MASTER} = 128\text{ kHz}$ | LSI RC osc. (128 kHz) | 0.55 | | | | |

1. Data based on characterization results, not tested in production.
2. Default clock configuration measured with all peripherals off.

تهیه و توزیع قطعات الکترونیک

Table 21. Total current consumption with code execution in run mode at $V_{DD} = 3.3\text{ V}$

| Symbol | Parameter | Conditions | Typ | Max ⁽¹⁾ | Unit | |
|--|--|--|------------------------------|--------------------|------|----|
| $I_{DD(RUN)}$ | Supply current in run mode, code executed from RAM | $f_{CPU} = f_{MASTER} = 24\text{ MHz}$, $T_A \leq 105\text{ °C}$ | HSE crystal osc. (24 MHz) | 4.0 | | mA |
| | | | HSE user ext. clock (24 MHz) | 3.7 | 7.3 | |
| | | $f_{CPU} = f_{MASTER} = 16\text{ MHz}$ | HSE crystal osc. (16 MHz) | 2.9 | | |
| | | | HSE user ext. clock (16 MHz) | 2.7 | 5.8 | |
| | | | HSI RC osc. (16 MHz) | 2.5 | 3.4 | |
| | | $f_{CPU} = f_{MASTER}/128 = 125\text{ kHz}$ | HSE user ext. clock (16 MHz) | 1.2 | 4.1 | |
| | | | HSI RC osc. (16 MHz) | 1.0 | 1.3 | |
| | $f_{CPU} = f_{MASTER}/128 = 15.625\text{ kHz}$ | HSI RC osc. (16MHz/8) | 0.55 | | | |
| | $f_{CPU} = f_{MASTER} = 128\text{ kHz}$ | LSI RC osc. (128 kHz) | 0.45 | | | |
| | Supply current in run mode, code executed from Flash | $f_{CPU} = f_{MASTER} = 24\text{ MHz}$, $T_A \leq 105\text{ °C}$ | HSE crystal osc. (24 MHz) | 11.0 | | |
| | | | HSE user ext. clock (24 MHz) | 10.8 | 18.0 | |
| | | $f_{CPU} = f_{MASTER} = 16\text{ MHz}$ | HSE crystal osc. (16 MHz) | 8.4 | | |
| | | | HSE user ext. clock (16 MHz) | 8.2 | 15.2 | |
| | | | HSI RC osc. (16 MHz) | 8.1 | 13.2 | |
| $f_{CPU} = f_{MASTER} = 2\text{ MHz}$. | | HSI RC osc. (16 MHz/8) ⁽²⁾ | 1.5 | | | |
| $f_{CPU} = f_{MASTER}/128 = 125\text{ kHz}$ | | HSI RC osc. (16 MHz) | 1.1 | | | |
| $f_{CPU} = f_{MASTER}/128 = 15.625\text{ kHz}$ | HSI RC osc. (16 MHz/8) | 0.6 | | | | |
| $f_{CPU} = f_{MASTER} = 128\text{ kHz}$ | LSI RC osc. (128 kHz) | 0.55 | | | | |

1. Data based on characterization results, not tested in production.
2. Default clock configuration.

SKYTECH

تهیه و توزیع قطعات الکترونیک

Total current consumption in wait mode

Table 22. Total current consumption in wait mode at V_{DD} = 5 V

| Symbol | Parameter | Conditions | Typ | Max ⁽¹⁾ | Unit | |
|--|-----------------------------|--|---------------------------------------|--------------------|------|----|
| I _{DD(WFI)} | Supply current in wait mode | f _{CPU} = f _{MASTER} = 24 MHz, T _A ≤ 105 °C | HSE crystal osc. (24 MHz) | 2.4 | | mA |
| | | | HSE user ext. clock (24 MHz) | 1.8 | 4.7 | |
| | | f _{CPU} = f _{MASTER} = 16 MHz | HSE crystal osc. (16 MHz) | 2.0 | | |
| | | | HSE user ext. clock (16 MHz) | 1.4 | 4.4 | |
| | | | HSI RC osc. (16 MHz) | 1.2 | 1.6 | |
| | | f _{CPU} = f _{MASTER} /128 = 125 kHz | HSI RC osc. (16 MHz) | 1.0 | | |
| | | f _{CPU} = f _{MASTER} /128 = 15.625 kHz | HSI RC osc. (16 MHz/8) ⁽²⁾ | 0.55 | | |
| f _{CPU} = f _{MASTER} = 128 kHz | LSI RC osc. (128 kHz) | 0.5 | | | | |

1. Data based on characterization results, not tested in production.
2. Default clock configuration measured with all peripherals off.

Table 23. Total current consumption in wait mode at V_{DD} = 3.3 V

| Symbol | Parameter | Conditions | Typ | Max ⁽¹⁾ | Unit | |
|--|-----------------------------|--|---------------------------------------|--------------------|------|----|
| I _{DD(WFI)} | Supply current in wait mode | f _{CPU} = f _{MASTER} = 24 MHz, T _A ≤ 105 °C | HSE crystal osc. (24 MHz) | 2.0 | | mA |
| | | | HSE user ext. clock (24 MHz) | 1.8 | 4.7 | |
| | | f _{CPU} = f _{MASTER} = 16 MHz | HSE crystal osc. (16 MHz) | 1.6 | | |
| | | | HSE user ext. clock (16 MHz) | 1.4 | 4.4 | |
| | | | HSI RC osc. (16 MHz) | 1.2 | 1.6 | |
| | | f _{CPU} = f _{MASTER} /128 = 125 kHz | HSI RC osc. (16 MHz) | 1.0 | | |
| | | f _{CPU} = f _{MASTER} /128 = 15.625 kHz | HSI RC osc. (16 MHz/8) ⁽²⁾ | 0.55 | | |
| f _{CPU} = f _{MASTER} /128 = 15.625 kHz | LSI RC osc. (128 kHz) | 0.5 | | | | |

1. Data based on characterization results, not tested in production.
2. Default clock configuration measured with all peripherals off.



تهیه و توزیع قطعات الکترونیک

Total current consumption in active halt mode

Table 24. Total current consumption in active halt mode at $V_{DD} = 5\text{ V}$, $T_A -40$ to 85° C

| Symbol | Parameter | Conditions | | | Typ | Max ⁽¹⁾ | Unit |
|--------------|------------------------------------|---|---------------------------|---------------------------------|------|--------------------|---------------|
| | | Main voltage regulator (MVR) ⁽²⁾ | Flash mode ⁽³⁾ | Clock source | | | |
| $I_{DD(AH)}$ | Supply current in active halt mode | On | Operating mode | HSE crystal oscillator (16 MHz) | 1000 | 260 | μA |
| | | | | LSI RC oscillator (128 kHz) | 200 | | |
| | | | Power-down mode | HSE crystal oscillator (16 MHz) | 940 | | |
| | | | | LSI RC oscillator (128 kHz) | 140 | | |
| | | Off | Operating mode | LSI RC oscillator 128 kHz) | 68 | | |
| | | | Power-down mode | | 11 | 45 | |

1. Data based on characterization results, not tested in production.
2. Configured by the REGAH bit in the CLK_ICKR register.
3. Configured by the AHALT bit in the FLASH_CR1 register.

Table 25. Total current consumption in active halt mode at $V_{DD} = 3.3\text{ V}$

| Symbol | Parameter | Conditions | | | Typ ⁽¹⁾ | Unit |
|--------------|------------------------------------|---|---------------------------|---------------------------|--------------------|---------------|
| | | Main voltage regulator (MVR) ⁽²⁾ | Flash mode ⁽³⁾ | Clock source | | |
| $I_{DD(AH)}$ | Supply current in active halt mode | On | Operating mode | HSE crystal osc. (16 MHz) | 600 | μA |
| | | | | LSI RC osc. (128 kHz) | 200 | |
| | | | Power-down mode | HSE crystal osc. (16 MHz) | 540 | |
| | | | | LSI RC osc. (128 kHz) | 140 | |
| | | Off | Operating mode | LSI RC osc. (128 kHz) | 66 | |
| | | | Power-down mode | | 9 | |

1. Data based on characterization results, not tested in production.
2. Configured by the REGAH bit in the CLK_ICKR register.
3. Configured by the AHALT bit in the FLASH_CR1 register.

تهیه و توزیع قطعات الکترونیک

Total current consumption in halt mode

Table 26. Total current consumption in halt mode at V_{DD} = 5 V

| Symbol | Parameter | Conditions | Typ | Max at 85 °C | Max at 125 °C | Unit |
|--------------------|-----------------------------|--|------|--------------|---------------|------|
| I _{DD(H)} | Supply current in halt mode | Flash in operating mode, HSI clock after wakeup | 63.5 | | | μA |
| | | Flash in power-down mode, HSI clock after wakeup | 6.5 | 35 | 100 | |

Table 27. Total current consumption in halt mode at V_{DD} = 3.3 V

| Symbol | Parameter | Conditions | Typ | Unit |
|--------------------|-----------------------------|--|------|------|
| I _{DD(H)} | Supply current in halt mode | Flash in operating mode, HSI clock after wakeup | 61.5 | μA |
| | | Flash in power-down mode, HSI clock after wakeup | 4.5 | |

Low power mode wakeup times

Table 28. Wakeup times

| Symbol | Parameter | Conditions | Typ | Max ⁽¹⁾ | Unit | |
|----------------------|--|--|---|-------------------------|------|------------------|
| t _{WU(WFI)} | Wakeup time from wait mode to run mode ⁽³⁾ | f _{CPU} = f _{MASTER} = 16 MHz. | 0.56 | See note ⁽²⁾ | μs | |
| t _{WU(AH)} | Wakeup time active halt mode to run mode. ⁽³⁾ | MVR voltage regulator on ⁽⁴⁾ | Flash in operating mode ⁽⁵⁾ | 1 ⁽⁶⁾ | | 2 ⁽⁶⁾ |
| | | MVR voltage regulator off ⁽⁴⁾ | Flash in power-down mode ⁽⁵⁾ | 3 ⁽⁶⁾ | | |
| | | | Flash in operating mode ⁽⁵⁾ | 48 ⁽⁶⁾ | | |
| | | Flash in power-down mode ⁽⁵⁾ | 50 ⁽⁶⁾ | | | |
| t _{WU(H)} | Wakeup time from halt mode to run mode ⁽³⁾ | Flash in operating mode ⁽⁵⁾ | 52 | | | |
| | | Flash in power-down mode ⁽⁵⁾ | 54 | | | |

1. Data guaranteed by design, not tested in production.
2. t_{WU(WFI)} = 2 x 1/f_{master} + 7 x 1/f_{CPU}
3. Measured from interrupt event to interrupt vector fetch.
4. Configured by the REGAH bit in the CLK_ICKR register.
5. Configured by the AHALT bit in the FLASH_CR1 register.
6. Plus 1 LSI clock depending on synchronization.

تهیه و توزیع قطعات الکترونیک

Total current consumption and timing in forced reset state

Table 29. Total current consumption and timing in forced reset state

| Symbol | Parameter | Conditions | Typ | Max ⁽¹⁾ | Unit |
|----------------------|--|-------------------------|-----|--------------------|------|
| I _{DD(R)} | Supply current in reset state | V _{DD} = 5 V | 1.6 | | mA |
| | | V _{DD} = 3.3 V | 0.8 | | |
| t _{RESETBL} | Reset release to bootloader vector fetch | | | 150 | µs |

1. Data guaranteed by design, not tested in production.

Current consumption of on-chip peripherals

Subject to general operating conditions for V_{DD} and T_A.

HSI internal RC/f_{CPU} = f_{MASTER} = 16 MHz.

Table 30. Peripheral current consumption

| Symbol | Parameter | Typ. | Unit |
|---------------------------------|--|------|------|
| I _{DD(TIM1)} | TIM1 supply current ⁽¹⁾ | 220 | µA |
| I _{DD(TIM2)} | TIM2 supply current ⁽¹⁾ | 120 | |
| I _{DD(TIM3)} | TIM3 timer supply current ⁽¹⁾ | 100 | |
| I _{DD(TIM4)} | TIM4 timer supply current ⁽¹⁾ | 25 | |
| I _{DD(UART1)} | UART1 supply current ⁽²⁾ | 90 | |
| I _{DD(UART3)} | UART3 supply current ⁽²⁾ | 110 | |
| I _{DD(SPI)} | SPI supply current ⁽²⁾ | 40 | |
| I _{DD(I²C)} | I ² C supply current ⁽²⁾ | 50 | |
| I _{DD(CAN)} | beCAN supply current ⁽²⁾ | 210 | |
| I _{DD(ADC2)} | ADC2 supply current when converting ⁽³⁾ | 1000 | |

1. Data based on a differential I_{DD} measurement between reset configuration and timer counter running at 16 MHz. No IC/OC programmed (no I/O pads toggling). Not tested in production.

2. Data based on a differential I_{DD} measurement between the on-chip peripheral when kept under reset and not clocked and the on-chip peripheral when clocked and not kept under reset. No I/O pads toggling. Not tested in production.

3. Data based on a differential I_{DD} measurement between reset configuration and continuous A/D conversions. Not tested in production.



تهیه و توزیع قطعات الکترونیک

Current consumption curves

Figure 14 and Figure 15 show typical current consumption measured with code executing in RAM.

Figure 14. Typ. $I_{DD(RUN)HS}$ vs V_{DD} , HSI RC osc, $f_{CPU} = 16$ MHz

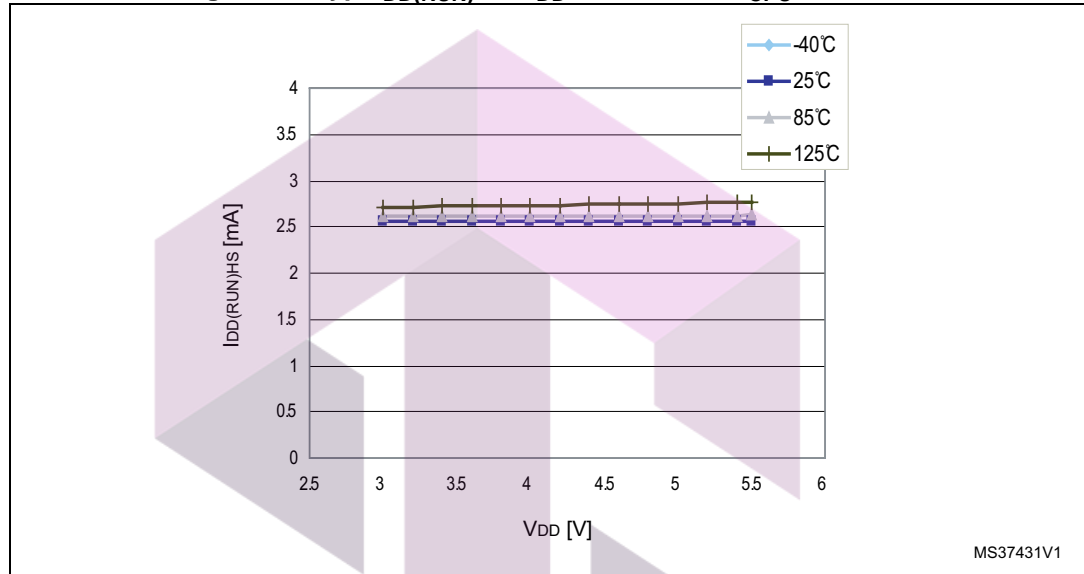
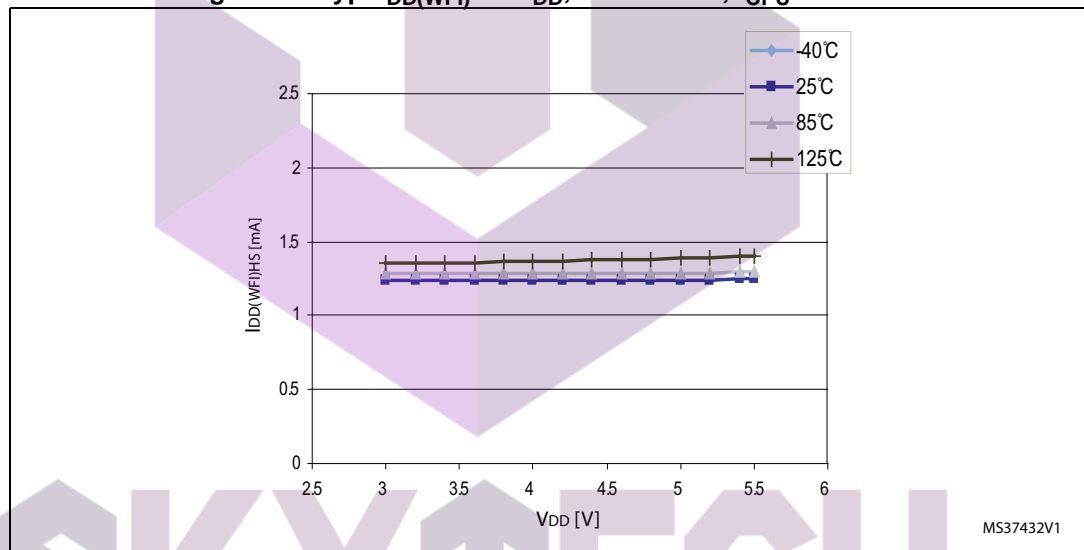


Figure 15. Typ. $I_{DD(WFI)HS}$ vs V_{DD} , HSI RC osc, $f_{CPU} = 16$ MHz



10.3.3 External clock sources and timing characteristics

HSE user external clock

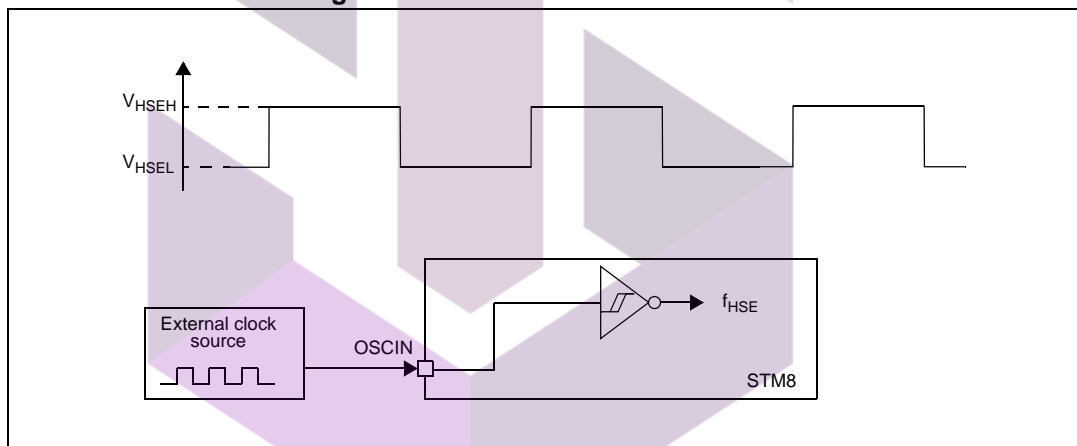
Subject to general operating conditions for V_{DD} and T_A .

Table 31. HSE user external clock characteristics

| Symbol | Parameter | Conditions | Min | Typ | Max | Unit |
|------------------|--------------------------------------|----------------------------|---------------------|-----|---------------------|---------|
| f_{HSE_ext} | User external clock source frequency | | 0 | | 24 | MHz |
| $V_{HSEH}^{(1)}$ | OSCIN input pin high level voltage | | $0.7 \times V_{DD}$ | | $V_{DD} + 0.3 V$ | V |
| $V_{HSEL}^{(1)}$ | OSCIN input pin low level voltage | | V_{SS} | | $0.3 \times V_{DD}$ | |
| I_{LEAK_HSE} | OSCIN input leakage current | $V_{SS} < V_{IN} < V_{DD}$ | -1 | | 1 | μA |

1. Data based on characterization results, not tested in production.

Figure 16. HSE external clock source



HSE crystal/ceramic resonator oscillator

The HSE clock can be supplied with a 1 to 24 MHz crystal/ceramic resonator oscillator. All the information given in this paragraph is based on characterization results with specified typical external components. In the application, the resonator and the load capacitors have to be placed as close as possible to the oscillator pins in order to minimize output distortion and start-up stabilization time. Refer to the crystal resonator manufacturer for more details (frequency, package, accuracy...).

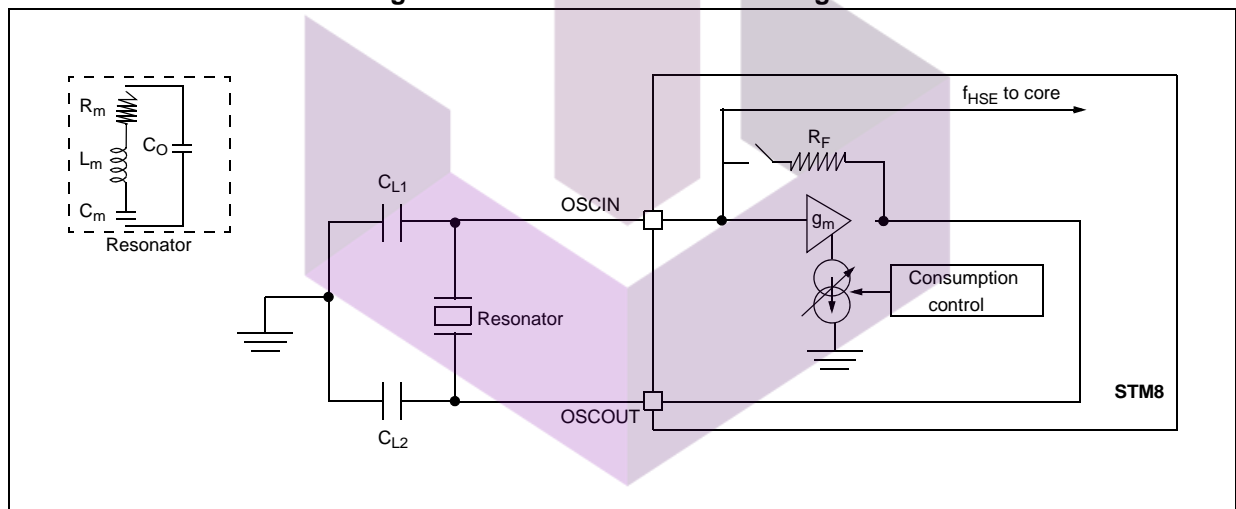


Table 32. HSE oscillator characteristics

| Symbol | Parameter | Conditions | Min | Typ | Max | Unit |
|---------------------|---|---|-----|-----|--|------------|
| f_{HSE} | External high speed oscillator frequency | | 1 | | 24 | MHz |
| R_F | Feedback resistor | | | 220 | | k Ω |
| $C^{(1)}$ | Recommended load capacitance ⁽²⁾ | | | | 20 | pF |
| $I_{DD(HSE)}$ | HSE oscillator power consumption | $C = 20 \text{ pF}$, $f_{OSC} = 24 \text{ MHz}$ | | | 6 (startup) 2 (stabilized) ⁽³⁾ | mA |
| | | $C = 10 \text{ pF}$, $f_{OSC} = 24 \text{ MHz}$ | | | 6 (startup) 1.5 (stabilized) ⁽³⁾ | |
| g_m | Oscillator transconductance | | 5 | | | mAV |
| $t_{SU(HSE)}^{(4)}$ | Startup time | V_{DD} is stabilized | | 1 | | ms |

1. C is approximately equivalent to 2 x crystal Cload.
2. The oscillator selection can be optimized in terms of supply current using a high quality resonator with small R_m value. Refer to crystal manufacturer for more details
3. Data based on characterization results, not tested in production.
4. $t_{SU(HSE)}$ is the start-up time measured from the moment it is enabled (by software) to a stabilized 24 MHz oscillation is reached. This value is measured for a standard crystal resonator and it can vary significantly with the crystal manufacturer.

Figure 17. HSE oscillator circuit diagram



HSE oscillator critical g_m formula

$$g_{m_{crit}} = (2 \times \pi \times f_{HSE})^2 \times R_m (2C_o + C)^2$$

- R_m : Notional resistance (see crystal specification)
- L_m : Notional inductance (see crystal specification)
- C_m : Notional capacitance (see crystal specification)
- C_o : Shunt capacitance (see crystal specification)
- $C_{L1}=C_{L2}=C$: Grounded external capacitance
- $g_m \gg g_{m_{crit}}$

تهیه و توزیع قطعات الکترونیک

10.3.4 Internal clock sources and timing characteristics

Subject to general operating conditions for V_{DD} and T_A . f_{HSE}

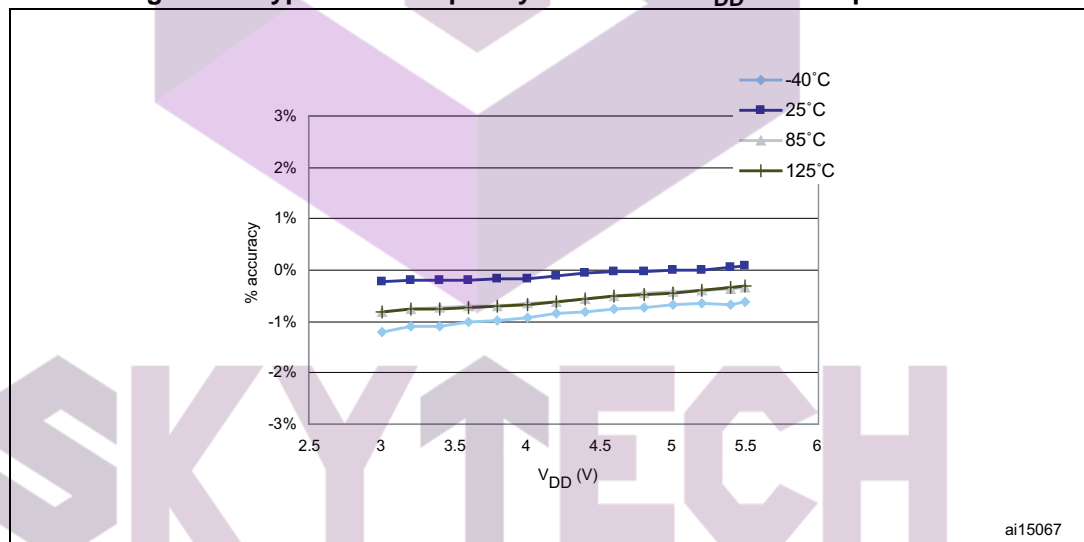
High speed internal RC oscillator (HSI)

Table 33. HSI oscillator characteristics

| Symbol | Parameter | Conditions | Min | Typ | Max | Unit |
|---------------|--|--|---------------------|-----|--------------------|---------------|
| f_{HSI} | Frequency | | | 16 | | MHz |
| ACC_{HSI} | Accuracy of HSI oscillator | Trimmed by the CLK_HSITRIMR register for given V_{DD} and T_A conditions | -1.0 ⁽¹⁾ | | 1.0 | % |
| | Accuracy of HSI oscillator (factory calibrated) | $V_{DD} = 5\text{ V}, T_A = 25\text{ °C}$ | -1.5 | | 1.5 | |
| | | $V_{DD} = 5\text{ V}, 25\text{ °C} \leq T_A \leq 85\text{ °C}$ | -2.2 | | 2.2 | |
| | | $2.95\text{ V} \leq V_{DD} \leq 5.5\text{ V}, -40\text{ °C} \leq T_A \leq 125\text{ °C}$ | -3.0 ⁽²⁾ | | 3.0 ⁽²⁾ | |
| $t_{su(HSI)}$ | HSI oscillator wakeup time including calibration | | | | 1.0 ⁽¹⁾ | μs |
| $I_{DD(HSI)}$ | HSI oscillator power consumption | | | 170 | 250 ⁽²⁾ | μA |

1. Guaranteed by design, not tested in production.
2. Data based on characterization results, not tested in production

Figure 18. Typical HSI frequency variation vs V_{DD} at 4 temperatures



تهیه و توزیع قطعات الکترونیک

Low speed internal RC oscillator (LSI)

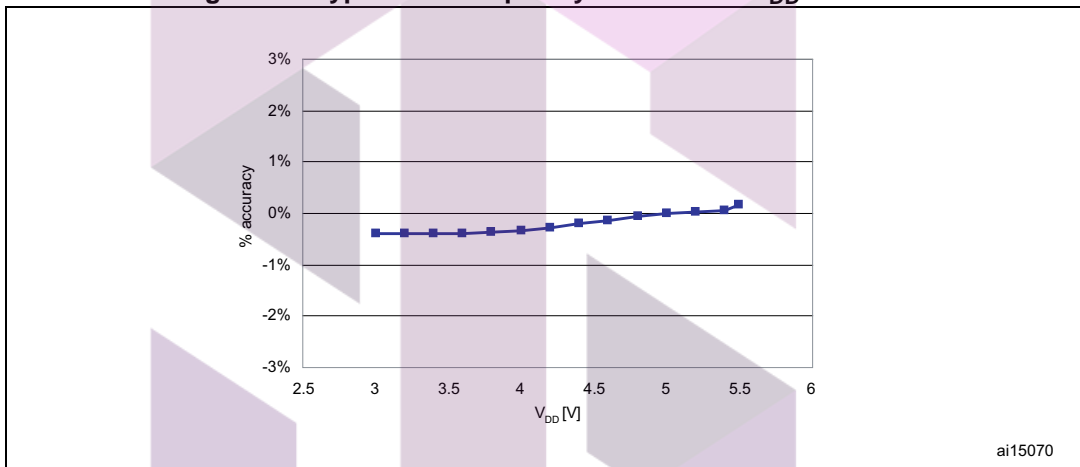
Subject to general operating conditions for V_{DD} and T_A .

Table 34. LSI oscillator characteristics

| Symbol | Parameter | Conditions | Min | Typ | Max | Unit |
|---------------|----------------------------------|------------|-----|-----|------------------|---------|
| f_{LSI} | Frequency | | 110 | 128 | 146 | kHz |
| $t_{su(LSI)}$ | LSI oscillator wakeup time | | | | 7 ⁽¹⁾ | μs |
| $I_{DD(LSI)}$ | LSI oscillator power consumption | | | 5 | | μA |

1. Guaranteed by design, not tested in production.

Figure 19. Typical LSI frequency variation vs V_{DD} @ 25 °C



SKYTECH

تهیه و توزیع قطعات الکترونیک

10.3.5 Memory characteristics

RAM and hardware registers

Table 35. RAM and hardware registers

| Symbol | Parameter | Conditions | Min | Unit |
|-----------------|------------------------------------|----------------------|------------------------------------|------|
| V _{RM} | Data retention mode ⁽¹⁾ | Halt mode (or reset) | V _{IT-max} ⁽²⁾ | V |

1. Minimum supply voltage without losing data stored in RAM (in halt mode or under reset) or in hardware registers (only in halt mode). Guaranteed by design, not tested in production.

2. Refer to [Table 19 on page 57](#) for the value of V_{IT-max}.

Flash program memory/data EEPROM memory

General conditions: T_A = -40 to 125 °C.

Table 36. Flash program memory/data EEPROM memory

| Symbol | Parameter | Conditions | Min ⁽¹⁾ | Typ | Max | Unit |
|--------------------|--|---------------------------|--------------------|-----|-----|--------|
| V _{DD} | Operating voltage (all modes, execution/write/erase) | f _{CPU} ≤ 24 MHz | 2.95 | | 5.5 | V |
| t _{prog} | Standard programming time (including erase) for byte/word/block (1 byte/4 bytes/128 bytes) | | | 6 | 6.6 | ms |
| | Fast programming time for 1 block (128 bytes) | | | 3 | 3.3 | ms |
| t _{erase} | Erase time for 1 block (128 bytes) | | | 3 | 3.3 | ms |
| N _{RW} | Erase/write cycles ⁽²⁾ (program memory) | T _A = 85 °C | 10 k | | | cycles |
| | Erase/write cycles (data memory) ⁽²⁾ | T _A = 125 °C | 300 k | 1M | | |
| t _{RET} | Data retention (program memory) after 10 k erase/write cycles at T _A = 85 °C | T _{RET} = 55° C | 20 | | | years |
| | Data retention (data memory) after 10 k erase/write cycles at T _A = 85 °C | T _{RET} = 55° C | 20 | | | |
| | Data retention (data memory) after 300k erase/write cycles at T _A = 125 °C | T _{RET} = 85° C | 1 | | | |
| I _{DD} | Supply current (Flash programming or erasing for 1 to 128 bytes) | | | 2 | | mA |

1. Data based on characterization results, not tested in production.

2. The physical granularity of the memory is 4 bytes, so cycling is performed on 4 bytes even when a write/erase operation addresses a single byte.

تهیه و توزیع قطعات الکترونیک

10.3.6 I/O port pin characteristics

General characteristics

Subject to general operating conditions for V_{DD} and T_A unless otherwise specified. All unused pins must be kept at a fixed voltage: using the output mode of the I/O for example or an external pull-up or pull-down resistor.

Table 37. I/O static characteristics

| Symbol | Parameter | Conditions | Min | Typ | Max | Unit |
|----------------------|--|---|---------------------|-----|--------------------------|---------------|
| V_{IL} | Input low level voltage | $V_{DD} = 5\text{ V}$ | -0.3 | | $0.3 \times V_{DD}$ | V |
| V_{IH} | Input high level voltage | | $0.7 \times V_{DD}$ | | $V_{DD} + 0.3\text{ V}$ | |
| V_{hys} | Hysteresis ⁽¹⁾ | | | | 700 | mV |
| R_{pu} | Pull-up resistor | $V_{DD} = 5\text{ V}, V_{IN} = V_{SS}$ | 30 | 55 | 80 | k Ω |
| t_R, t_F | Rise and fall time (10% - 90%) | Fast I/Os Load = 50 pF | | | 20 ⁽²⁾ | ns |
| | | Standard and high sink I/Os Load = 50 pF | | | 125 ⁽²⁾ | |
| | | Fast I/Os Load = 20 pF | | | 35 ⁽³⁾ | |
| | | Standard and high sink I/Os Load = 20 pF | | | 125 ⁽³⁾ | |
| I_{lkg} | Input leakage current, analog and digital | $V_{SS} \leq V_{IN} \leq V_{DD}$ | | | ± 1 | μA |
| $I_{lkg\text{ ana}}$ | Analog input leakage current | $V_{SS} \leq V_{IN} \leq V_{DD}$ | | | ± 250 ⁽²⁾ | nA |
| $I_{lkg(inj)}$ | Leakage current in adjacent I/O ⁽²⁾ | Injection current $\pm 4\text{ mA}$ | | | ± 1 ⁽²⁾ | μA |

1. Hysteresis voltage between Schmitt trigger switching levels. Based on characterization results, not tested in production.
2. Data based on characterization results, not tested in production.
3. Guaranteed by design.



 تهیه و توزیع قطعات الکترونیک

Figure 20. Typical V_{IL} and V_{IH} vs V_{DD} @ 4 temperatures

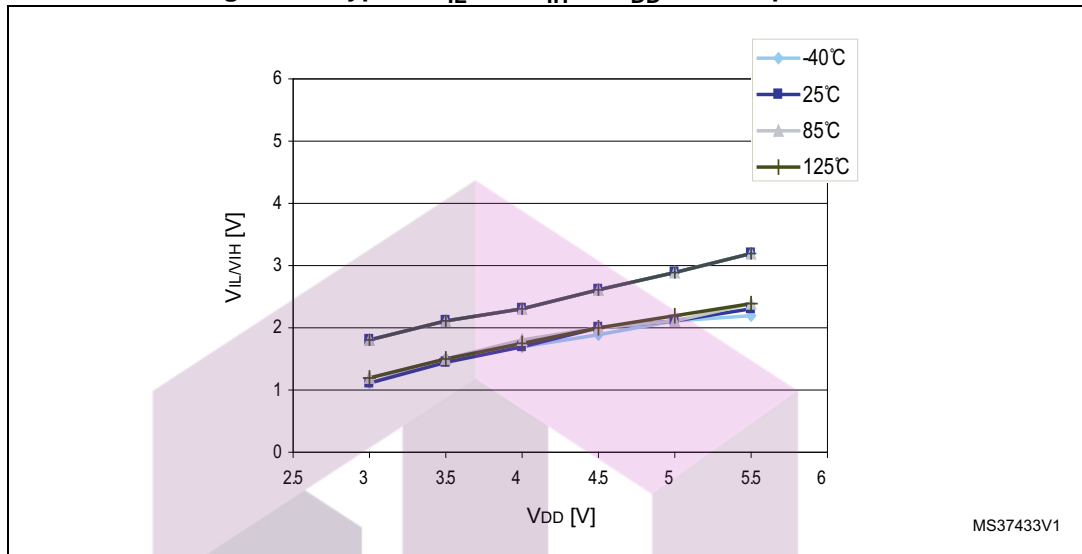
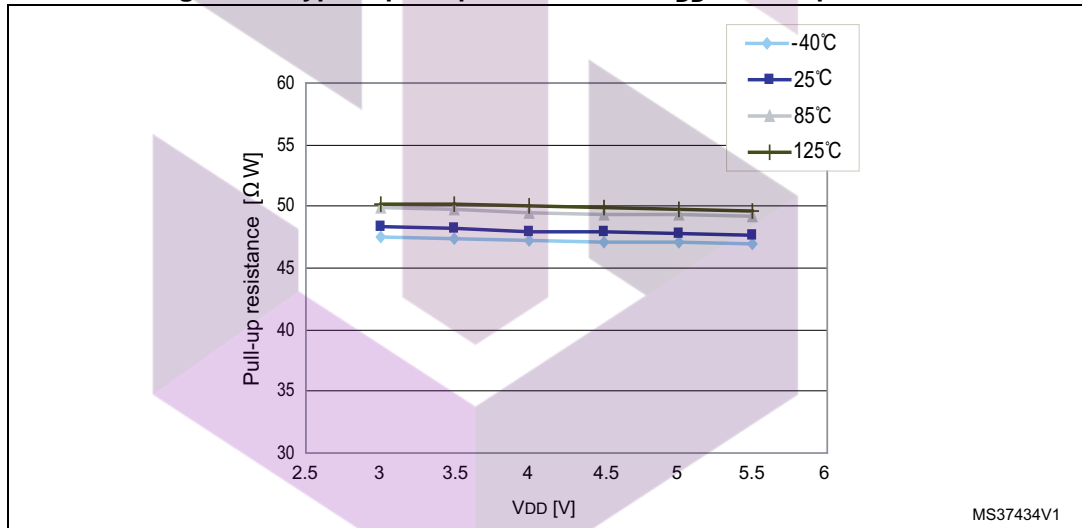


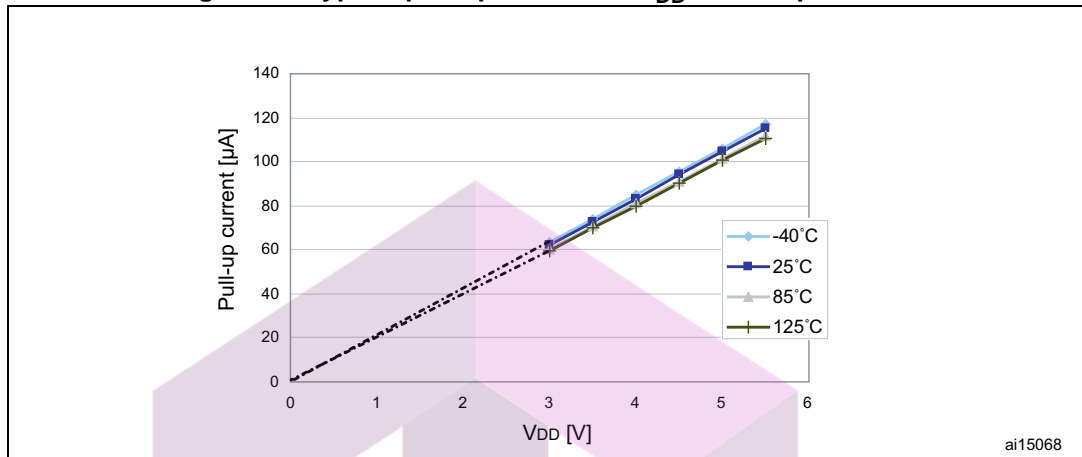
Figure 21. Typical pull-up resistance vs V_{DD} @ 4 temperatures



SKYTECH

تهیه و توزیع قطعات الکترونیک

Figure 22. Typical pull-up current vs V_{DD} @ 4 temperatures



1. The pull-up is a pure resistor (slope goes through 0).

Table 38. Output driving current (standard ports)

| Symbol | Parameter | Conditions | Min | Max | Unit |
|----------|---------------------------------------|--|--------------------|------------------|------|
| V_{OL} | Output low level with 8 pins sunk | $I_{IO} = 10 \text{ mA}$, $V_{DD} = 5 \text{ V}$ | | 2 | V |
| | Output low level with 4 pins sunk | $I_{IO} = 4 \text{ mA}$, $V_{DD} = 3.3 \text{ V}$ | | 1 ⁽¹⁾ | |
| V_{OH} | Output high level with 8 pins sourced | $I_{IO} = 10 \text{ mA}$, $V_{DD} = 5 \text{ V}$ | 2.8 | | V |
| | Output high level with 4 pins sourced | $I_{IO} = 4 \text{ mA}$, $V_{DD} = 3.3 \text{ V}$ | 2.1 ⁽¹⁾ | | |

1. Data based on characterization results, not tested in production

Table 39. Output driving current (true open drain ports)

| Symbol | Parameter | Conditions | Max | Unit |
|----------|-----------------------------------|---|--------------------|------|
| V_{OL} | Output low level with 2 pins sunk | $I_{IO} = 10 \text{ mA}$, $V_{DD} = 5 \text{ V}$ | 1 | V |
| | | $I_{IO} = 10 \text{ mA}$, $V_{DD} = 3.3 \text{ V}$ | 1.5 ⁽¹⁾ | |
| | | $I_{IO} = 20 \text{ mA}$, $V_{DD} = 5 \text{ V}$ | 2 ⁽¹⁾ | |

1. Data based on characterization results, not tested in production

Table 40. Output driving current (high sink ports)

| Symbol | Parameter | Conditions | Min | Max | Unit |
|----------|---------------------------------------|---|--------------------|--------------------|------|
| V_{OL} | Output low level with 8 pins sunk | $I_{IO} = 10 \text{ mA}$, $V_{DD} = 5 \text{ V}$ | | 0.8 | V |
| | Output low level with 4 pins sunk | $I_{IO} = 10 \text{ mA}$, $V_{DD} = 3.3 \text{ V}$ | | 1 ⁽¹⁾ | |
| | Output low level with 4 pins sunk | $I_{IO} = 20 \text{ mA}$, $V_{DD} = 5 \text{ V}$ | | 1.5 ⁽¹⁾ | |
| V_{OH} | Output high level with 8 pins sourced | $I_{IO} = 10 \text{ mA}$, $V_{DD} = 5 \text{ V}$ | 4.0 | | V |
| | Output high level with 4 pins sourced | $I_{IO} = 10 \text{ mA}$, $V_{DD} = 3.3 \text{ V}$ | 2.1 ⁽¹⁾ | | |
| | Output high level with 4 pins sourced | $I_{IO} = 20 \text{ mA}$, $V_{DD} = 5 \text{ V}$ | 3.3 ⁽¹⁾ | | |

1. Data based on characterization results, not tested in production

Typical output level curves

Figure 24 to Figure 31 show typical output level curves measured with output on a single pin.

Figure 23. Typ. V_{OL} @ $V_{DD} = 5\text{ V}$ (standard ports)

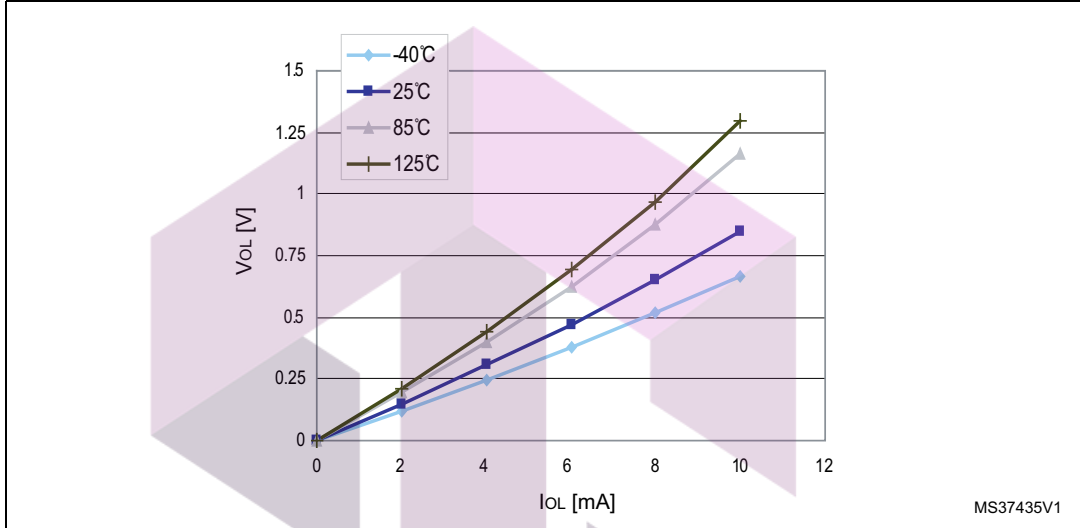
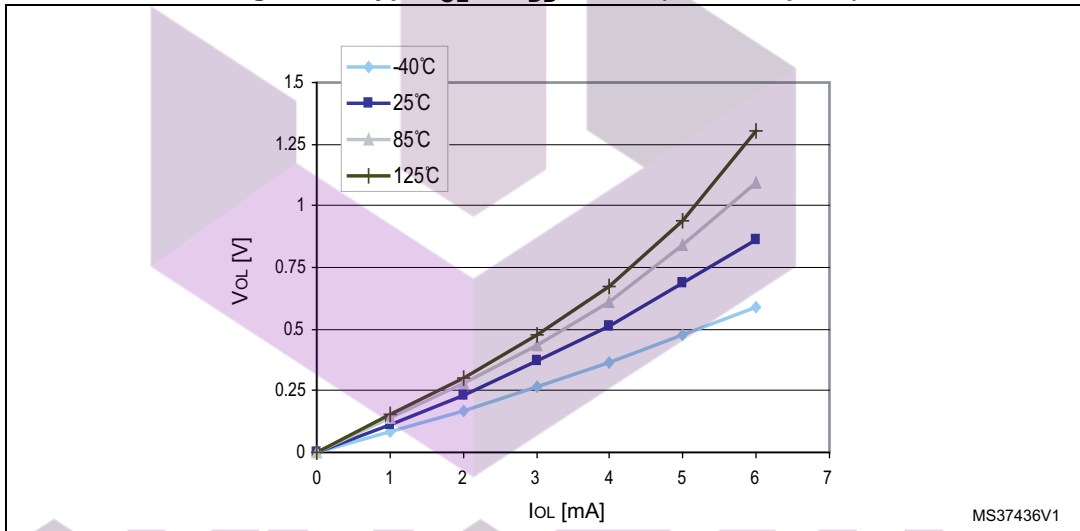


Figure 24. Typ. V_{OL} @ $V_{DD} = 3.3\text{ V}$ (standard ports)



SKYTECH

تهیه و توزیع قطعات الکترونیک

Figure 25. Typ. V_{OL} @ $V_{DD} = 5\text{ V}$ (true open drain ports)

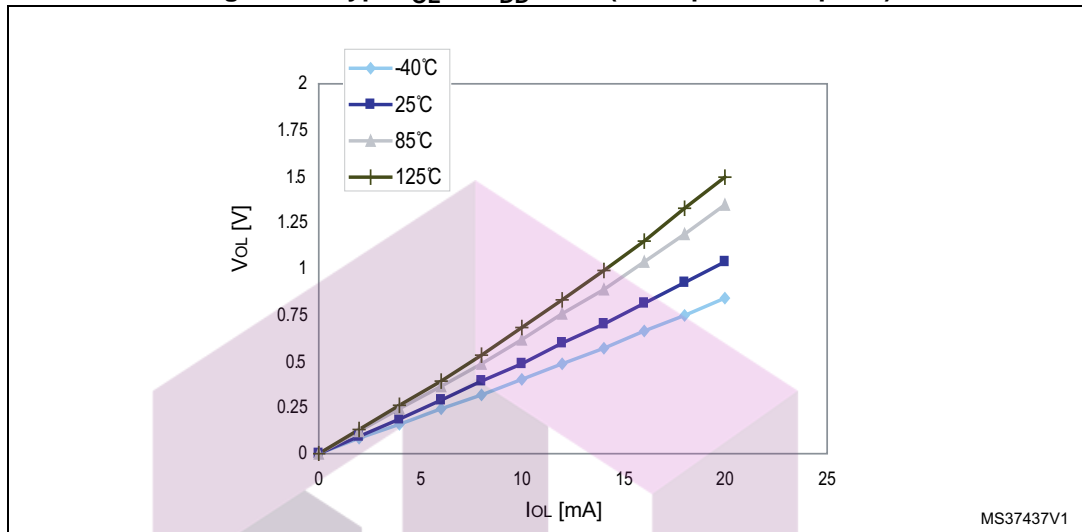
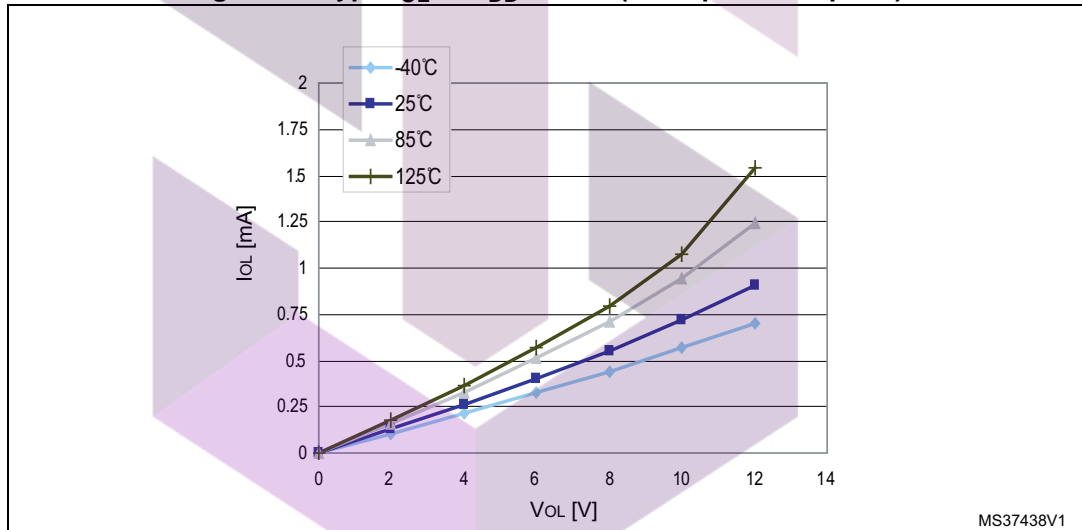


Figure 26. Typ. V_{OL} @ $V_{DD} = 3.3\text{ V}$ (true open drain ports)



SKYTECH

تهیه و توزیع قطعات الکترونیک

Figure 27. Typ. V_{OL} @ $V_{DD} = 5\text{ V}$ (high sink ports)

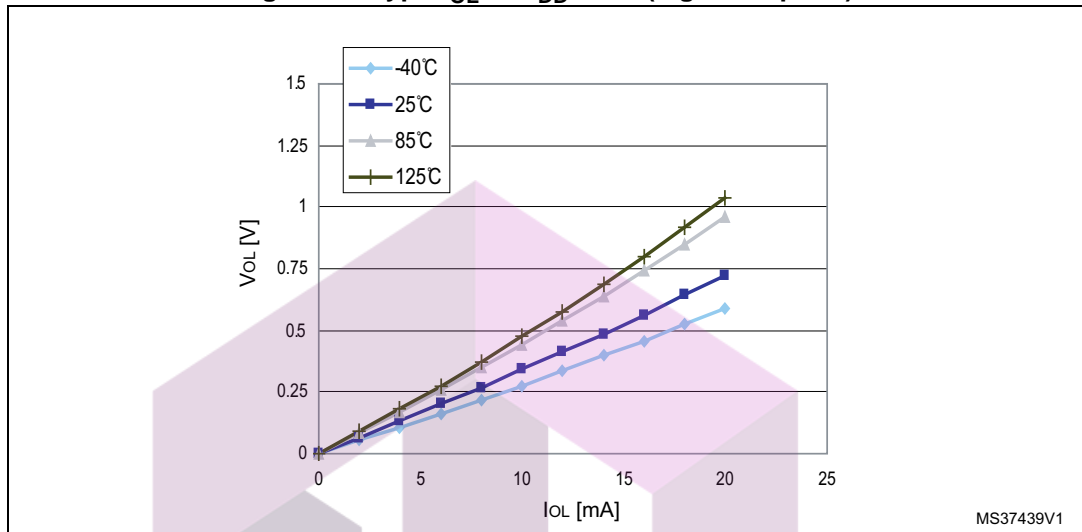
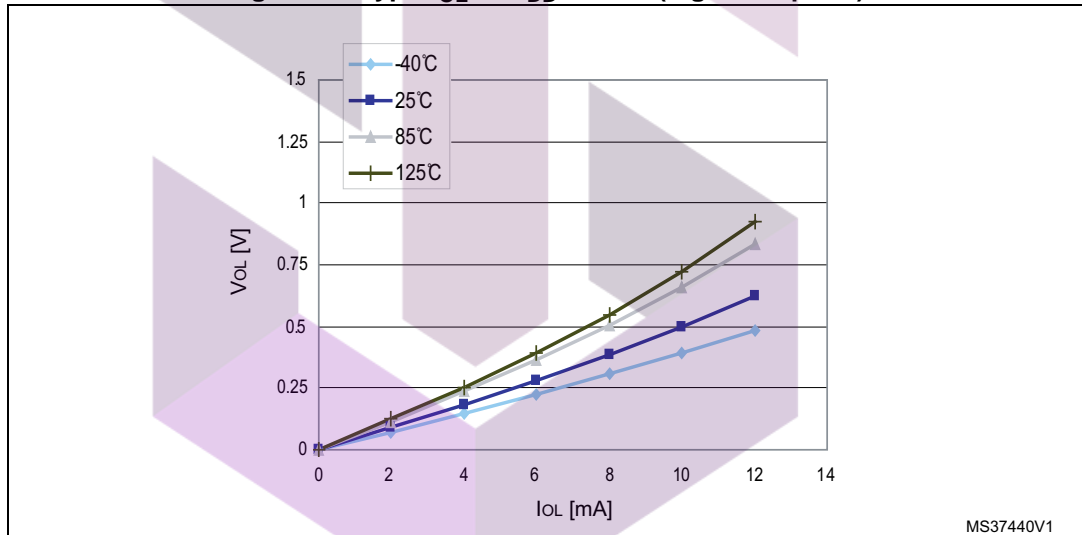


Figure 28. Typ. V_{OL} @ $V_{DD} = 3.3\text{ V}$ (high sink ports)



SKYTECH

تهیه و توزیع قطعات الکترونیک

Figure 29. Typ. $V_{DD} - V_{OH}$ @ $V_{DD} = 5\text{ V}$ (standard ports)

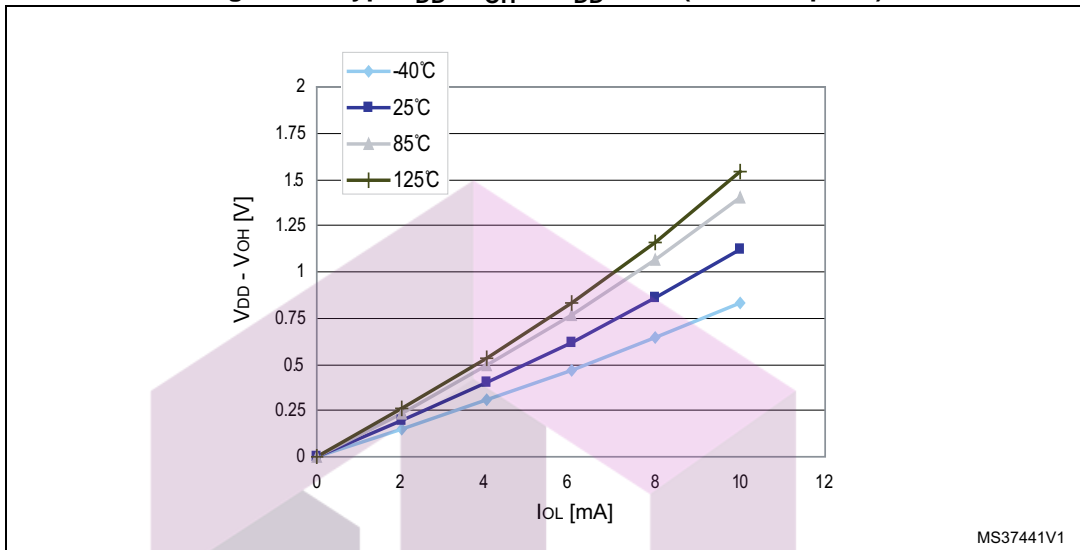
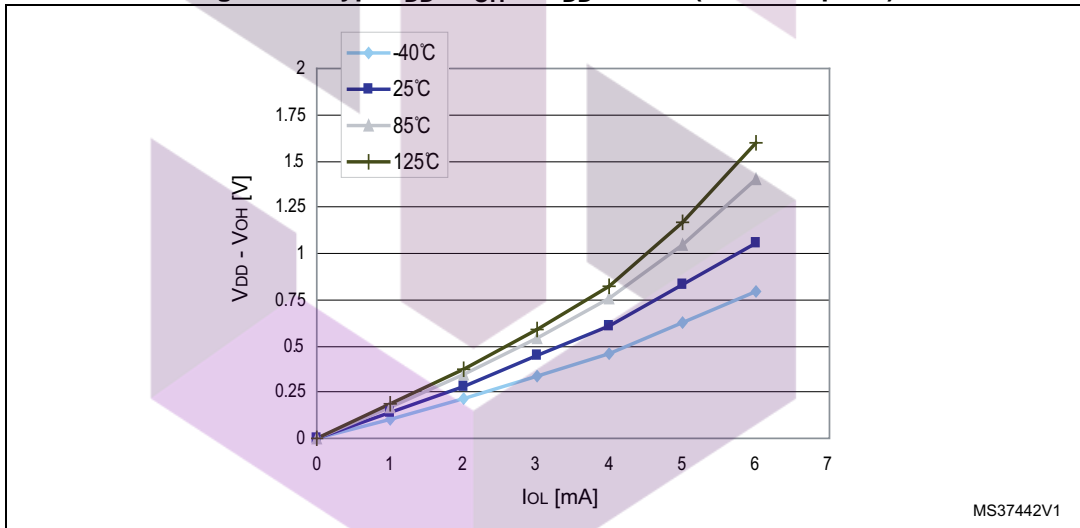


Figure 30. Typ. $V_{DD} - V_{OH}$ @ $V_{DD} = 3.3\text{ V}$ (standard ports)



SKYTECH

تهیه و توزیع قطعات الکترونیک

Figure 31. Typ. $V_{DD} - V_{OH}$ @ $V_{DD} = 5\text{ V}$ (high sink ports)

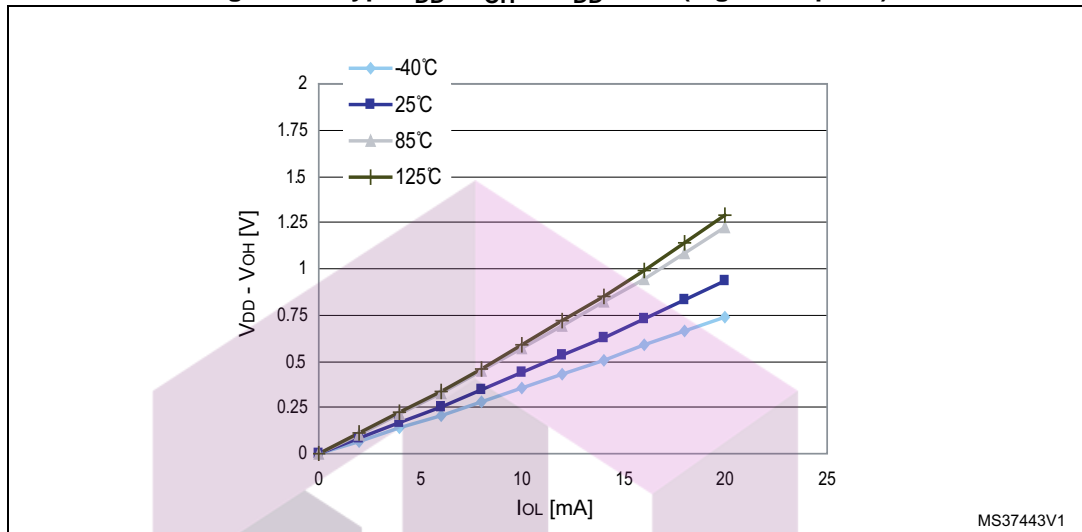
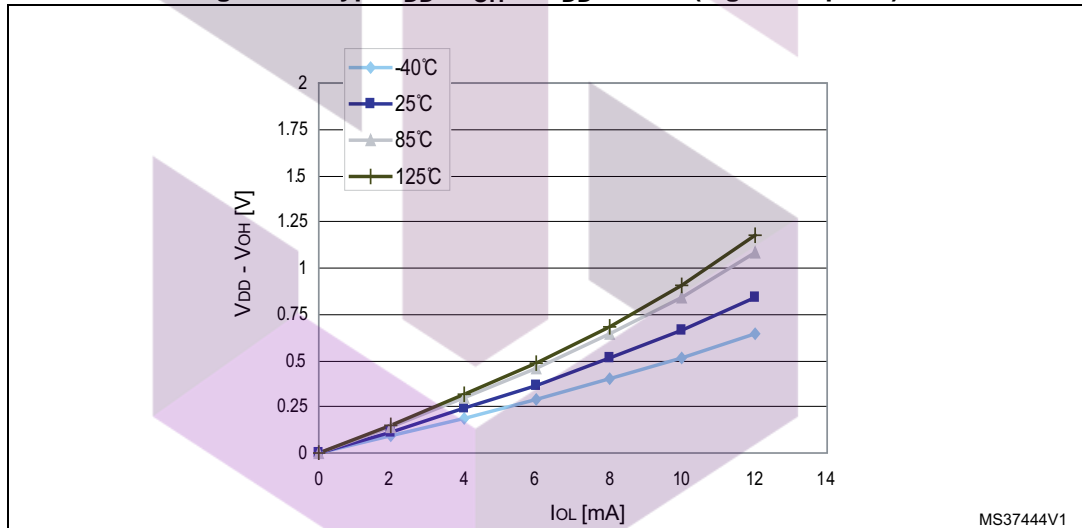


Figure 32. Typ. $V_{DD} - V_{OH}$ @ $V_{DD} = 3.3\text{ V}$ (high sink ports)



SKYTECH

تهیه و توزیع قطعات الکترونیک

10.3.7 Reset pin characteristics

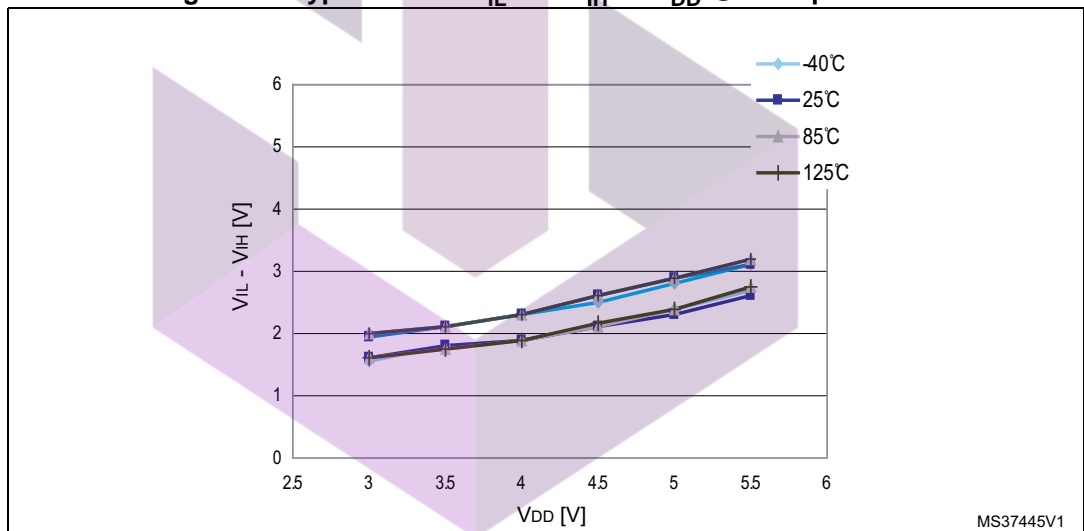
Subject to general operating conditions for V_{DD} and T_A unless otherwise specified.

Table 41. NRST pin characteristics

| Symbol | Parameter | Conditions | Min | Typ ¹⁾ | Max | Unit |
|------------------|--|-------------------------|---------------------|-------------------|---------------------|---------------|
| $V_{IL(NRST)}$ | NRST Input low level voltage ⁽¹⁾ | | -0.3 V | | $0.3 \times V_{DD}$ | V |
| $V_{IH(NRST)}$ | NRST Input high level voltage ⁽¹⁾ | | $0.7 \times V_{DD}$ | | $V_{DD} + 0.3$ | |
| $V_{OL(NRST)}$ | NRST Output low level voltage ⁽¹⁾ | $I_{OL} = 2 \text{ mA}$ | | | 0.5 | |
| $R_{PU(NRST)}$ | NRST Pull-up resistor ⁽²⁾ | | 30 | 55 | 80 | k Ω |
| $t_{IFP(NRST)}$ | NRST Input filtered pulse ⁽³⁾ | | | | 75 | ns |
| $t_{INFP(NRST)}$ | NRST Input not filtered pulse ⁽³⁾ | | 500 | | | ns |
| $t_{OP(NRST)}$ | NRST output pulse ⁽¹⁾ | | 15 | | | μs |

1. Data based on characterization results, not tested in production.
2. The R_{PU} pull-up equivalent resistor is based on a resistive transistor
3. Data guaranteed by design, not tested in production.

Figure 33. Typical NRST V_{IL} and V_{IH} vs V_{DD} @ 4 temperatures



SKYTECH

تهیه و توزیع قطعات الکترونیک

Figure 34. Typical NRST pull-up resistance vs V_{DD} @ 4 temperatures

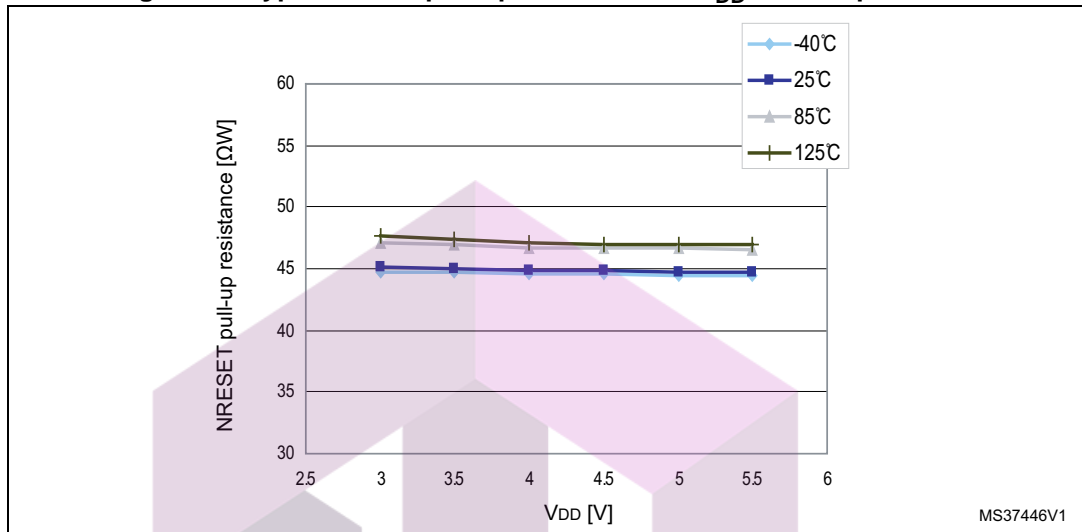
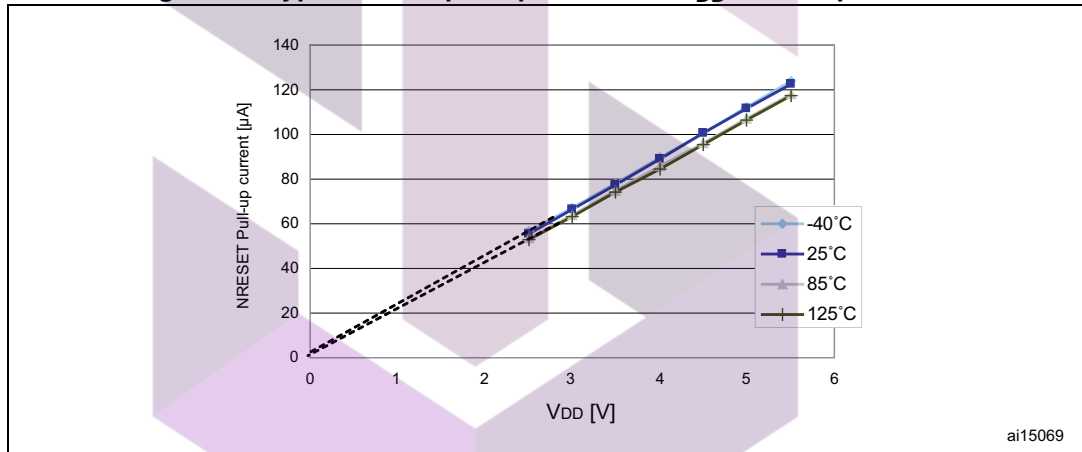
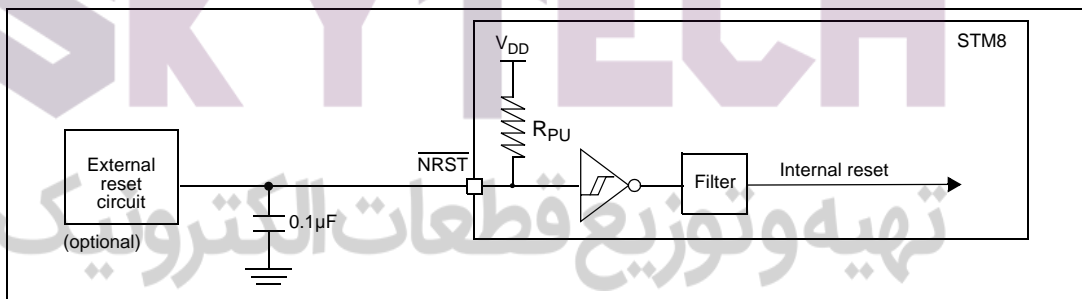


Figure 35. Typical NRST pull-up current vs V_{DD} @ 4 temperatures



The reset network shown in [Figure 36](#) protects the device against parasitic resets. The user must ensure that the level on the NRST pin can go below the V_{IL} max. level specified in [Table 41](#). Otherwise the reset is not taken into account internally. For power consumption sensitive applications, the capacity of the external reset capacitor can be reduced to limit charge/discharge current. If the NRST signal is used to reset the external circuitry, care must be taken of the charge/discharge time of the external capacitor to fulfill the external device's reset timing conditions. The minimum recommended capacity is 10 nF.

Figure 36. Recommended reset pin protection



10.3.8 SPI serial peripheral interface

Unless otherwise specified, the parameters given in [Table 42](#) are derived from tests performed under ambient temperature, f_{MASTER} frequency and V_{DD} supply voltage conditions. $t_{\text{MASTER}} = 1/f_{\text{MASTER}}$.

Refer to I/O port characteristics for more details on the input/output alternate function characteristics (NSS, SCK, MOSI, MISO).

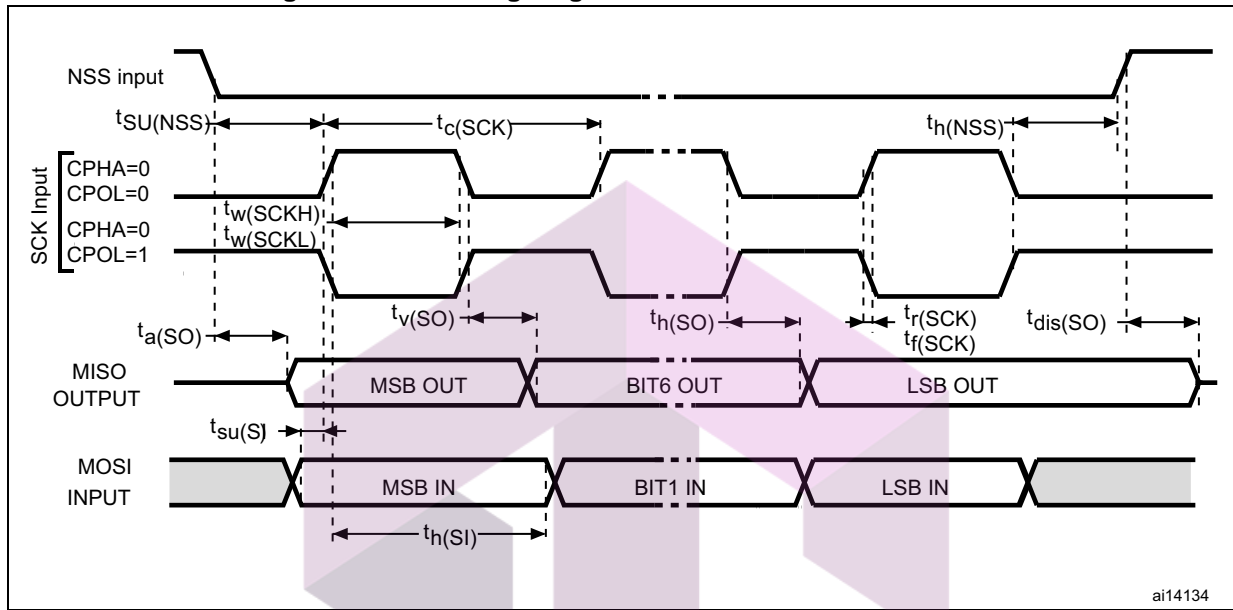
Table 42. SPI characteristics

| Symbol | Parameter | Conditions | Min | Max | Unit |
|--|------------------------------|---------------------------------|------------------------------|------------------------------|------|
| f_{SCK} $1/t_{\text{c(SCK)}}$ | SPI clock frequency | Master mode | 0 | 10 | MHz |
| | | Slave mode | 0 | 6 | |
| $t_{\text{r(SCK)}}$ $t_{\text{f(SCK)}}$ | SPI clock rise and fall time | Capacitive load: C = 30 pF | | 25 | ns |
| $t_{\text{su(NSS)}}^{(1)}$ | NSS setup time | Slave mode | $4 \times t_{\text{MASTER}}$ | | |
| $t_{\text{h(NSS)}}^{(1)}$ | NSS hold time | Slave mode | 70 | | |
| $t_{\text{w(SCKH)}}^{(1)}$ $t_{\text{w(SCKL)}}^{(1)}$ | SCK high and low time | Master mode | $t_{\text{SCK}}/2 - 15$ | $t_{\text{SCK}}/2 + 15$ | |
| $t_{\text{su(MI)}}^{(1)}$ $t_{\text{su(SI)}}^{(1)}$ | Data input setup time | Master mode | 5 | | |
| | | Slave mode | 5 | | |
| $t_{\text{h(MI)}}^{(1)}$ $t_{\text{h(SI)}}^{(1)}$ | Data input hold time | Master mode | 7 | | |
| | | Slave mode | 10 | | |
| $t_{\text{a(SO)}}^{(1)(2)}$ | Data output access time | Slave mode | | $3 \times t_{\text{MASTER}}$ | |
| $t_{\text{dis(SO)}}^{(1)(3)}$ | Data output disable time | Slave mode | 25 | | |
| $t_{\text{v(SO)}}^{(1)}$ | Data output valid time | Slave mode (after enable edge) | | 75 | |
| $t_{\text{v(MO)}}^{(1)}$ | Data output valid time | Master mode (after enable edge) | | 30 | |
| $t_{\text{h(SO)}}^{(1)}$ $t_{\text{h(MO)}}^{(1)}$ | Data output hold time | Slave mode (after enable edge) | 31 | | |
| | | Master mode (after enable edge) | 12 | | |

1. Values based on design simulation and/or characterization results, and not tested in production.
2. Min time is for the minimum time to drive the output and the max time is for the maximum time to validate the data.
3. Min time is for the minimum time to invalidate the output and the max time is for the maximum time to put the data in Hi-Z.

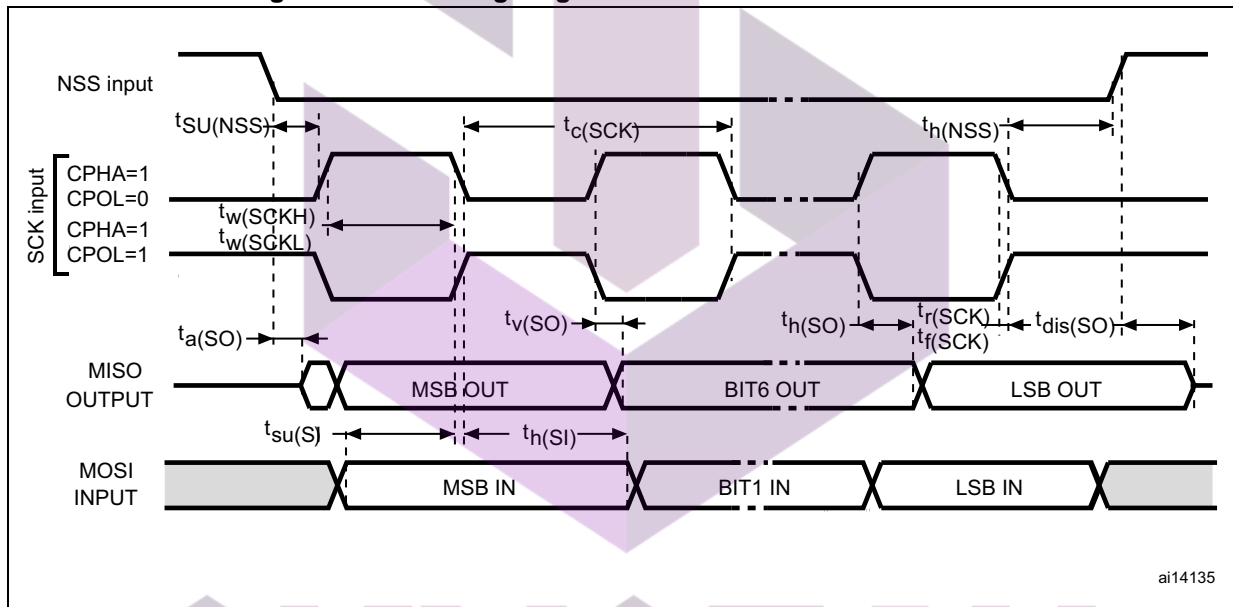


Figure 37. SPI timing diagram - slave mode and CPHA = 0



ai14134

Figure 38. SPI timing diagram - slave mode and CPHA = 1⁽¹⁾



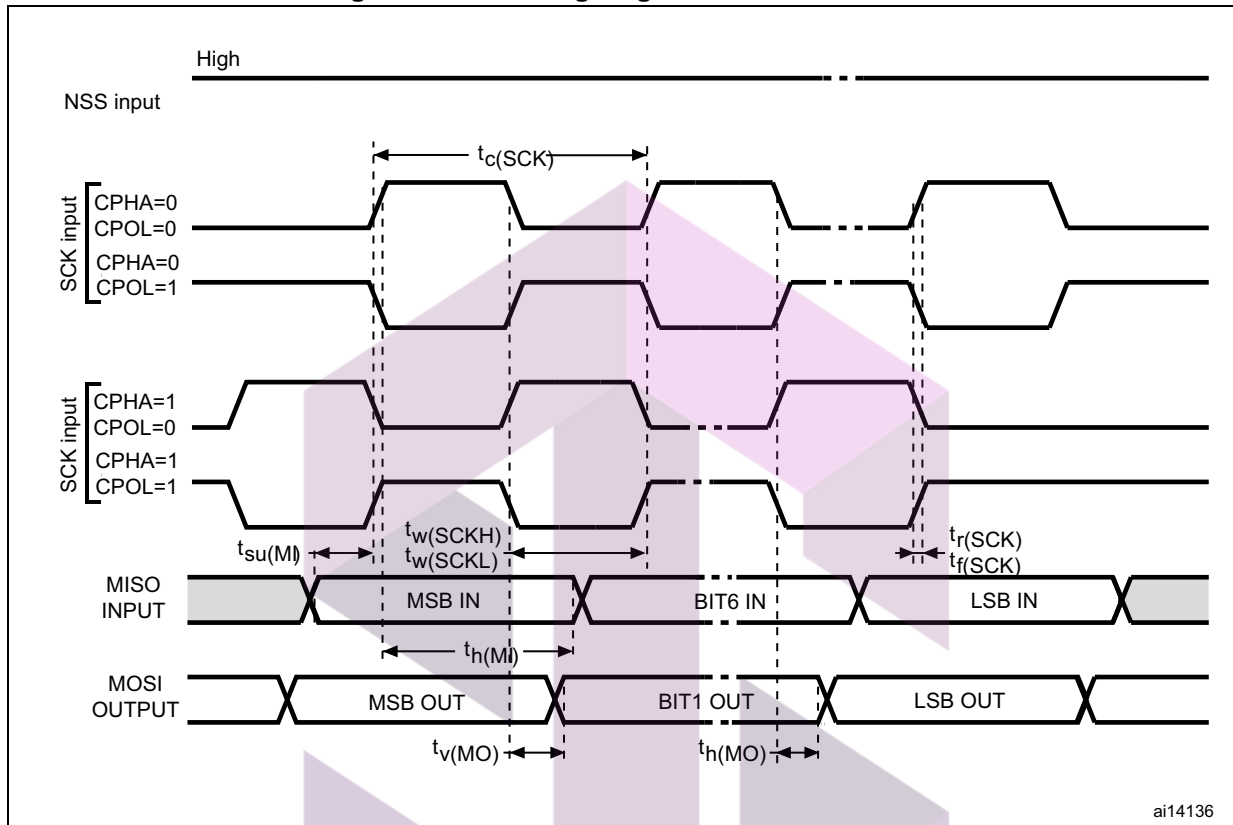
ai14135

1. Measurement points are done at CMOS levels: 0.3 V_{DD} and 0.7 V_{DD} .

SKYTECH

تهیه و توزیع قطعات الکترونیک

Figure 39. SPI timing diagram - master mode⁽¹⁾



1. Measurement points are done at CMOS levels: 0.3 V_{DD} and 0.7 V_{DD}.

SKYTECH

تهیه و توزیع قطعات الکترونیک

10.3.9 I²C interface characteristicsTable 43. I²C characteristics

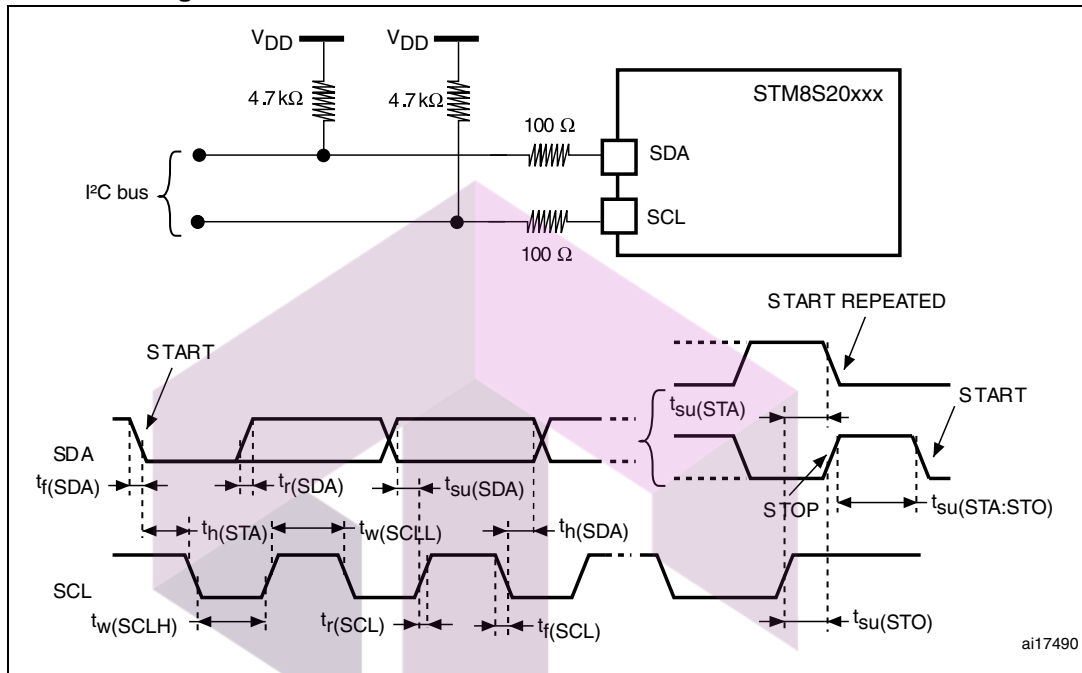
| Symbol | Parameter | Standard mode I ² C | | Fast mode I ² C ⁽¹⁾ | | Unit |
|--|---|--------------------------------|--------------------|---|--------------------|------|
| | | Min ⁽²⁾ | Max ⁽²⁾ | Min ⁽²⁾ | Max ⁽²⁾ | |
| t _{w(SCLL)} | SCL clock low time | 4.7 | | 1.3 | | μs |
| t _{w(SCLH)} | SCL clock high time | 4.0 | | 0.6 | | |
| t _{su(SDA)} | SDA setup time | 250 | | 100 | | ns |
| t _{h(SDA)} | SDA data hold time | 0 ⁽³⁾ | | 0 ⁽⁴⁾ | 900 ⁽³⁾ | |
| t _{r(SDA)} t _{r(SCL)} | SDA and SCL rise time | | 1000 | | 300 | |
| t _{f(SDA)} t _{f(SCL)} | SDA and SCL fall time | | 300 | | 300 | |
| t _{h(STA)} | START condition hold time | 4.0 | | 0.6 | | μs |
| t _{su(STA)} | Repeated START condition setup time | 4.7 | | 0.6 | | |
| t _{su(STO)} | STOP condition setup time | 4.0 | | 0.6 | | μs |
| t _{w(STO:STA)} | STOP to START condition time (bus free) | 4.7 | | 1.3 | | μs |
| C _b | Capacitive load for each bus line | | 400 | | 400 | pF |

1. f_{MASTER}, must be at least 8 MHz to achieve max fast I²C speed (400kHz)
2. Data based on standard I²C protocol requirement, not tested in production
3. The maximum hold time of the start condition has only to be met if the interface does not stretch the low time
4. The device must internally provide a hold time of at least 300 ns for the SDA signal in order to bridge the undefined region of the falling edge of SCL

SKYTECH

تهیه و توزیع قطعات الکترونیک

Figure 40. Typical application with I²C bus and timing diagram



1. Measurement points are made at CMOS levels: 0.3 x V_{DD} and 0.7 x V_{DD}

SKYTECH
 تهیه و توزیع قطعات الکترونیک

10.3.10 10-bit ADC characteristics

Subject to general operating conditions for V_{DDA} , f_{MASTER} , and T_A unless otherwise specified.

Table 44. ADC characteristics

| Symbol | Parameter | Conditions | Min | Typ | Max | Unit |
|-------------|--|--|---------------------|-----|--------------------|-------------|
| f_{ADC} | ADC clock frequency | $V_{DDA} = 3$ to 5.5 V | 1 | | 4 | MHz |
| | | $V_{DDA} = 4.5$ to 5.5 V | 1 | | 6 | |
| V_{DDA} | Analog supply | | 3 | | 5.5 | V |
| V_{REF+} | Positive reference voltage | | 2.75 ⁽¹⁾ | | V_{DDA} | V |
| V_{REF-} | Negative reference voltage | | V_{SSA} | | 0.5 ⁽¹⁾ | V |
| V_{AIN} | Conversion voltage range ⁽²⁾ | | V_{SSA} | | V_{DDA} | V |
| | | Devices with external V_{REF+}/V_{REF-} pins | V_{REF-} | | V_{REF+} | V |
| C_{ADC} | Internal sample and hold capacitor | | | 3 | | pF |
| $t_S^{(2)}$ | Sampling time | $f_{ADC} = 4$ MHz | 0.75 | | | μ s |
| | | $f_{ADC} = 6$ MHz | 0.5 | | | |
| t_{STAB} | Wakeup time from standby | | | 7 | | μ s |
| t_{CONV} | Total conversion time (including sampling time, 10-bit resolution) | $f_{ADC} = 4$ MHz | 3.5 | | | μ s |
| | | $f_{ADC} = 6$ MHz | 2.33 | | | μ s |
| | | | 14 | | | $1/f_{ADC}$ |

1. Data guaranteed by design, not tested in production.
2. During the sample time the input capacitance C_{AIN} (3 pF max) can be charged/discharged by the external source. The internal resistance of the analog source must allow the capacitance to reach its final voltage level within t_S . After the end of the sample time t_S , changes of the analog input voltage have no effect on the conversion result. Values for the sample clock t_S depend on programming.

SKYTECH

تهیه و توزیع قطعات الکترونیک

Table 45. ADC accuracy with $R_{AIN} < 10\text{ k}\Omega$, $V_{DDA} = 5\text{ V}$

| Symbol | Parameter | Conditions | Typ | Max ⁽¹⁾ | Unit |
|----------------|---|--------------------------|-----|--------------------|------|
| E _T | Total unadjusted error ⁽²⁾ | f _{ADC} = 2 MHz | 1 | 2.5 | LSB |
| | | f _{ADC} = 4 MHz | 1.4 | 3 | |
| | | f _{ADC} = 6 MHz | 1.6 | 3.5 | |
| E _O | Offset error ⁽²⁾ | f _{ADC} = 2 MHz | 0.6 | 2 | |
| | | f _{ADC} = 4 MHz | 1.1 | 2.5 | |
| | | f _{ADC} = 6 MHz | 1.2 | 2.5 | |
| E _G | Gain error ⁽²⁾ | f _{ADC} = 2 MHz | 0.2 | 2 | |
| | | f _{ADC} = 4 MHz | 0.6 | 2.5 | |
| | | f _{ADC} = 6 MHz | 0.8 | 2.5 | |
| E _D | Differential linearity error ⁽²⁾ | f _{ADC} = 2 MHz | 0.7 | 1.5 | |
| | | f _{ADC} = 4 MHz | 0.7 | 1.5 | |
| | | f _{ADC} = 6 MHz | 0.8 | 1.5 | |
| E _L | Integral linearity error ⁽²⁾ | f _{ADC} = 2 MHz | 0.6 | 1.5 | |
| | | f _{ADC} = 4 MHz | 0.6 | 1.5 | |
| | | f _{ADC} = 6 MHz | 0.6 | 1.5 | |

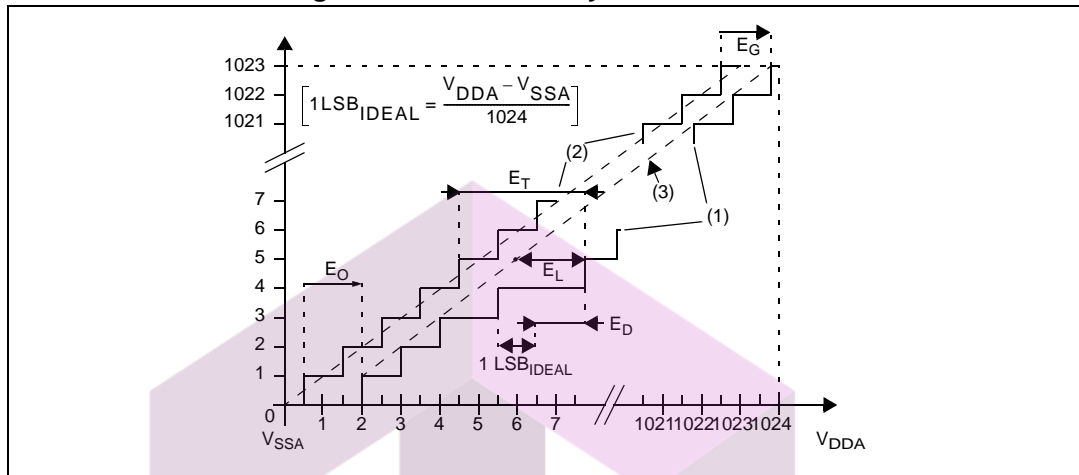
1. Data based on characterization results for LQFP80 device with V_{REF+}/V_{REF-}, not tested in production.
2. ADC accuracy vs. negative injection current: Injecting negative current on any of the analog input pins should be avoided as this significantly reduces the accuracy of the conversion being performed on another analog input. It is recommended to add a Schottky diode (pin to ground) to standard analog pins which may potentially inject negative current. Any positive injection current within the limits specified for I_{INJ(PIN)} and ΣI_{INJ(PIN)} in [Section 10.3.6](#) does not affect the ADC accuracy.

Table 46. ADC accuracy with $R_{AIN} < 10\text{ k}\Omega$, $V_{DDA} = 3.3\text{ V}$

| Symbol | Parameter | Conditions | Typ | Max ⁽¹⁾ | Unit |
|----------------|---|--------------------------|-----|--------------------|------|
| E _T | Total unadjusted error ⁽²⁾ | f _{ADC} = 2 MHz | 1.1 | 2 | LSB |
| | | f _{ADC} = 4 MHz | 1.6 | 2.5 | |
| E _O | Offset error ⁽²⁾ | f _{ADC} = 2 MHz | 0.7 | 1.5 | |
| | | f _{ADC} = 4 MHz | 1.3 | 2 | |
| E _G | Gain error ⁽²⁾ | f _{ADC} = 2 MHz | 0.2 | 1.5 | |
| | | f _{ADC} = 4 MHz | 0.5 | 2 | |
| E _D | Differential linearity error ⁽²⁾ | f _{ADC} = 2 MHz | 0.7 | 1 | |
| | | f _{ADC} = 4 MHz | 0.7 | 1 | |
| E _L | Integral linearity error ⁽²⁾ | f _{ADC} = 2 MHz | 0.6 | 1.5 | |
| | | f _{ADC} = 4 MHz | 0.6 | 1.5 | |

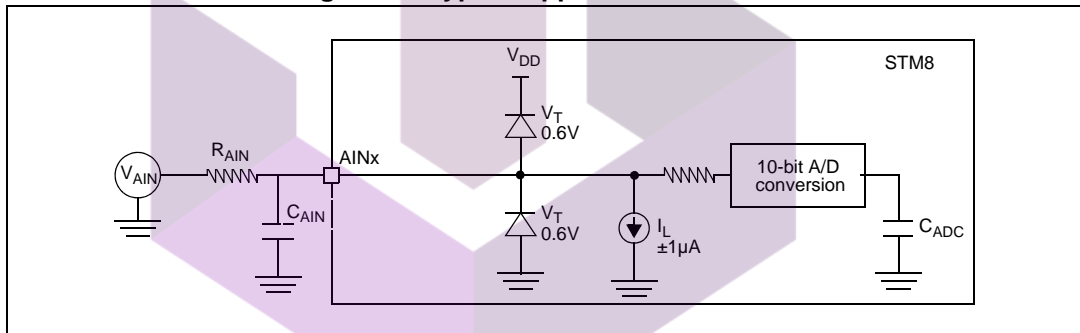
تهیه و توزیع قطعات الکترونیک

Figure 41. ADC accuracy characteristics



1. Example of an actual transfer curve.
 2. The ideal transfer curve
 3. End point correlation line
- ET** = Total unadjusted error: maximum deviation between the actual and the ideal transfer curves.
EO = Offset error: deviation between the first actual transition and the first ideal one.
EG = Gain error: deviation between the last ideal transition and the last actual one.
ED = Differential linearity error: maximum deviation between actual steps and the ideal one.
EL = Integral linearity error: maximum deviation between any actual transition and the end point correlation line.

Figure 42. Typical application with ADC





 تهیه و توزیع قطعات الکترونیک

10.3.11 EMC characteristics

Susceptibility tests are performed on a sample basis during product characterization.

Functional EMS (electromagnetic susceptibility)

While executing a simple application (toggling 2 LEDs through I/O ports), the product is stressed by two electromagnetic events until a failure occurs (indicated by the LEDs).

- **ESD:** Electrostatic discharge (positive and negative) is applied on all pins of the device until a functional disturbance occurs. This test conforms with the IEC 61000-4-2 standard.
- **FTB:** A burst of fast transient voltage (positive and negative) is applied to V_{DD} and V_{SS} through a 100 pF capacitor, until a functional disturbance occurs. This test conforms with the IEC 61000-4-4 standard.

A device reset allows normal operations to be resumed. The test results are given in the table below based on the EMS levels and classes defined in application note AN1709.

Designing hardened software to avoid noise problems

EMC characterization and optimization are performed at component level with a typical application environment and simplified MCU software. It should be noted that good EMC performance is highly dependent on the user application and the software in particular.

Therefore it is recommended that the user applies EMC software optimization and prequalification tests in relation with the EMC level requested for his application.

Software recommendations

The software flowchart must include the management of runaway conditions such as:

- Corrupted program counter
- Unexpected reset
- Critical data corruption (control registers...)

Prequalification trials

Most of the common failures (unexpected reset and program counter corruption) can be recovered by applying a low state on the NRST pin or the oscillator pins for 1 second.

To complete these trials, ESD stress can be applied directly on the device, over the range of specification values. When unexpected behavior is detected, the software can be hardened to prevent unrecoverable errors occurring (see application note AN1015).

Table 47. EMS data

| Symbol | Parameter | Conditions | Level/class |
|------------|--|---|-------------|
| V_{FESD} | Voltage limits to be applied on any I/O pin to induce a functional disturbance | $V_{DD} = 5\text{ V}$, $T_A = 25\text{ }^\circ\text{C}$, $f_{MASTER} = 16\text{ MHz}$, conforming to IEC 61000-4-2 | 2B |
| V_{EFTB} | Fast transient voltage burst limits to be applied through 100pF on V_{DD} and V_{SS} pins to induce a functional disturbance | $V_{DD} = 5\text{ V}$, $T_A = 25\text{ }^\circ\text{C}$, $f_{MASTER} = 16\text{ MHz}$, conforming to IEC 61000-4-4 | 4A |

Electromagnetic interference (EMI)

Emission tests conform to the SAE IEC 61967-2 standard for test software, board layout and pin loading.

Table 48. EMI data

| Symbol | Parameter | Conditions | | | | | Unit |
|-----------|---------------|--|--------------------------|-----------------------------|--------------|--------------|------------|
| | | General conditions | Monitored frequency band | Max $f_{HSE}/f_{CPU}^{(1)}$ | | | |
| | | | | 8 MHz/8 MHz | 8 MHz/16 MHz | 8 MHz/24 MHz | |
| S_{EMI} | Peak level | $V_{DD} = 5\text{ V}$ $T_A = 25\text{ °C}$ LQFP80 package conforming to SAE IEC 61967-2 | 0.1MHz to 30 MHz | 15 | 20 | 24 | dB μ V |
| | | | 30 MHz to 130 MHz | 18 | 21 | 16 | |
| | | | 130 MHz to 1 GHz | -1 | 1 | 4 | |
| | SAE EMI level | | SAE EMI level | 2 | 2.5 | 2.5 | |

1. Data based on characterization results, not tested in production.

Absolute maximum ratings (electrical sensitivity)

Based on two different tests (ESD and LU) using specific measurement methods, the product is stressed in order to determine its performance in terms of electrical sensitivity. For more details, refer to the application note AN1181.

Electrostatic discharge (ESD)

Electrostatic discharges (3 positive then 3 negative pulses separated by 1 second) are applied to the pins of each sample according to each pin combination. The sample size depends on the number of supply pins in the device (3 parts*(n+1) supply pin). This test conforms to the JESD22-A114A/A115A standard. For more details, refer to the application note AN1181.

Table 49. ESD absolute maximum ratings

| Symbol | Ratings | Conditions | Class | Maximum value ⁽¹⁾ | Unit |
|----------------|---|---|-------|------------------------------|------|
| $V_{ESD(HBM)}$ | Electrostatic discharge voltage (Human body model) | $T_A = 25\text{°C}$, conforming to JESD22-A114 | A | 2000 | V |
| $V_{ESD(CDM)}$ | Electrostatic discharge voltage (Charge device model) | $T_A = 25\text{°C}$, conforming to JESD22-C101 | IV | 1000 | V |

1. Data based on characterization results, not tested in production.

تهیه و توزیع قطعات الکترونیک

Static latch-up

Two complementary static tests are required on 10 parts to assess the latch-up performance:

- A supply overvoltage (applied to each power supply pin)
- A current injection (applied to each input, output and configurable I/O pin) is performed on each sample.

This test conforms to the EIA/JESD 78 IC latch-up standard. For more details, refer to the application note AN1181.

Table 50. Electrical sensitivities

| Symbol | Parameter | Conditions | Class ⁽¹⁾ |
|--------|-----------------------|-------------------------|----------------------|
| LU | Static latch-up class | T _A = 25 °C | A |
| | | T _A = 85 °C | A |
| | | T _A = 125 °C | A |

1. Class description: A Class is an STMicroelectronics internal specification. All its limits are higher than the JEDEC specifications, that means when a device belongs to class A it exceeds the JEDEC standard. B class strictly covers all the JEDEC criteria (international standard).

SKYTECH

تهیه و توزیع قطعات الکترونیک

11 Package characteristics

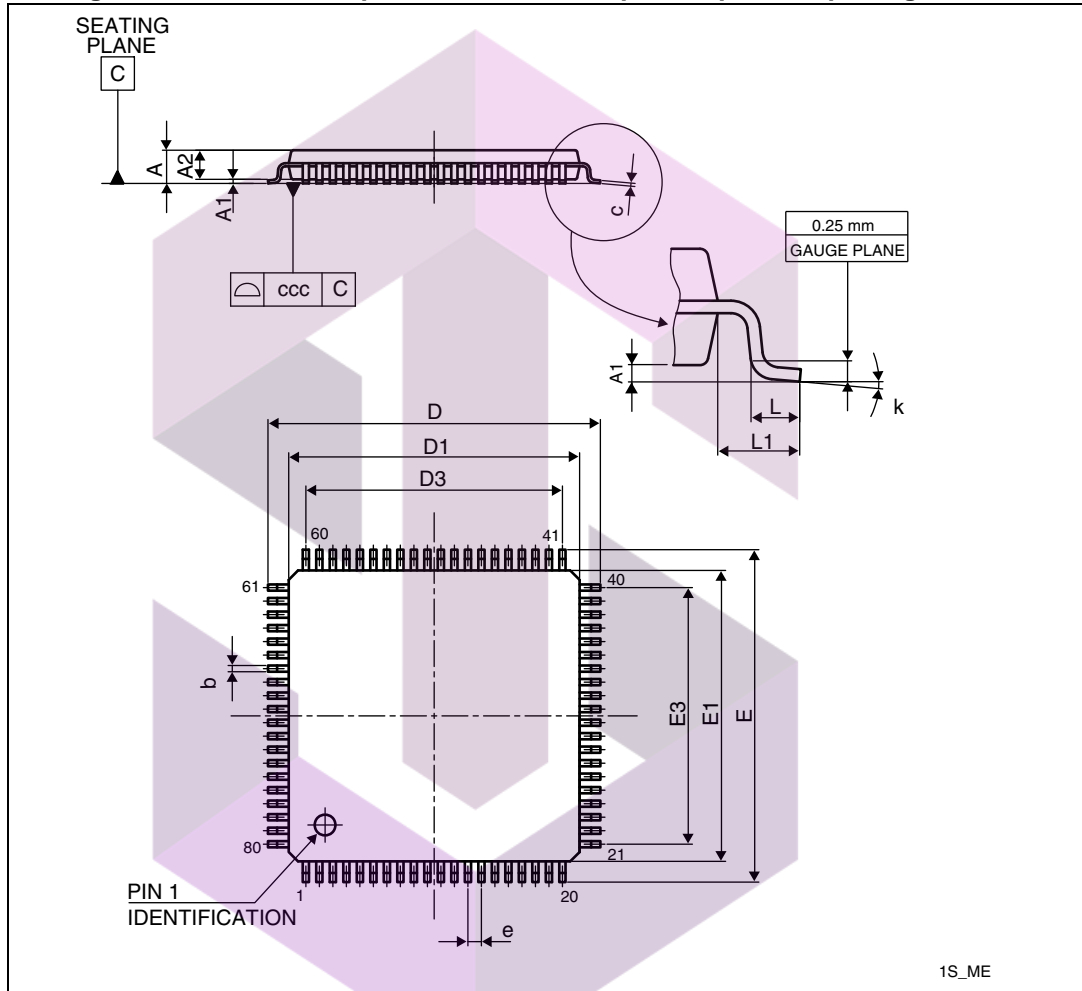
To meet environmental requirements, ST offers these devices in different grades of ECOPACK® packages, depending on their level of environmental compliance. ECOPACK® specifications, grade definitions and product status are available at www.st.com. ECOPACK® is an ST trademark.



11.1 Package information

11.1.1 LQFP80 package information

Figure 43. LQFP80 - 80-pin, 14 x 14 mm low-profile quad flat package outline



1. Drawing is not to scale.

Table 51. LQFP80 - 80-pin, 14 x 14 mm low-profile quad flat package mechanical data⁽¹⁾

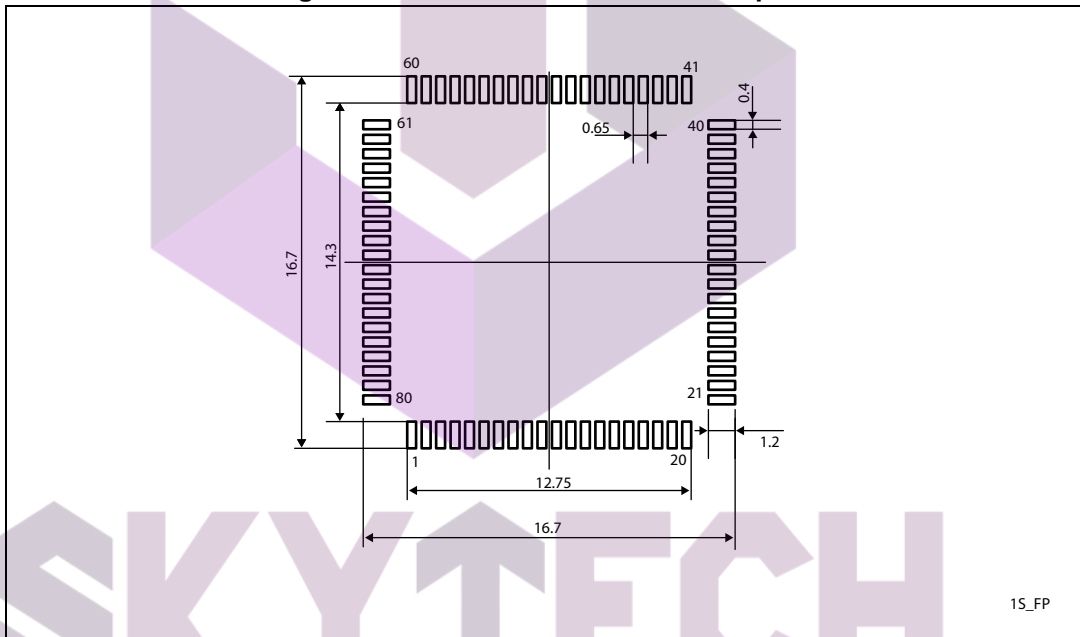
| Symbol | millimeters | | | inches | | |
|--------|-------------|-------|-------|--------|--------|--------|
| | Min | Typ | Max | Min | Typ | Max |
| A | - | - | 1.600 | - | - | 0.0630 |
| A1 | 0.050 | - | 0.150 | 0.0020 | - | 0.0059 |
| A2 | 1.350 | 1.400 | 1.450 | 0.0531 | 0.0551 | 0.0571 |
| b | 0.220 | 0.320 | 0.380 | 0.0087 | 0.0126 | 0.0150 |
| c | 0.090 | - | 0.200 | 0.0035 | - | 0.0079 |

Table 51. LQFP80 - 80-pin, 14 x 14 mm low-profile quad flat package mechanical data⁽¹⁾ (continued)

| Symbol | millimeters | | | inches | | |
|--------|-------------|--------|--------|--------|--------|--------|
| | Min | Typ | Max | Min | Typ | Max |
| D | 15.800 | 16.000 | 16.200 | 0.6220 | 0.6299 | 0.6378 |
| D1 | 13.800 | 14.000 | 14.200 | 0.5433 | 0.5512 | 0.5591 |
| D3 | - | 12.350 | - | - | 0.4862 | - |
| E | 15.800 | 16.000 | 16.200 | 0.6220 | 0.6299 | 0.6378 |
| E1 | 13.800 | 14.000 | 14.200 | 0.5433 | 0.5512 | 0.5591 |
| E3 | - | 12.350 | - | - | 0.4862 | - |
| e | - | 0.650 | - | - | 0.0256 | - |
| L | 0.450 | 0.600 | 0.750 | 0.0177 | 0.0236 | 0.0295 |
| L1 | - | 1.000 | - | - | 0.0394 | - |
| k | 0° | 3.5° | 7° | 0° | 3.5° | 7° |
| ccc | - | - | 0.100 | - | - | 0.0039 |

1. Values in inches are converted from mm and rounded to 4 decimal digits.

Figure 44. LQFP80 recommended footprint

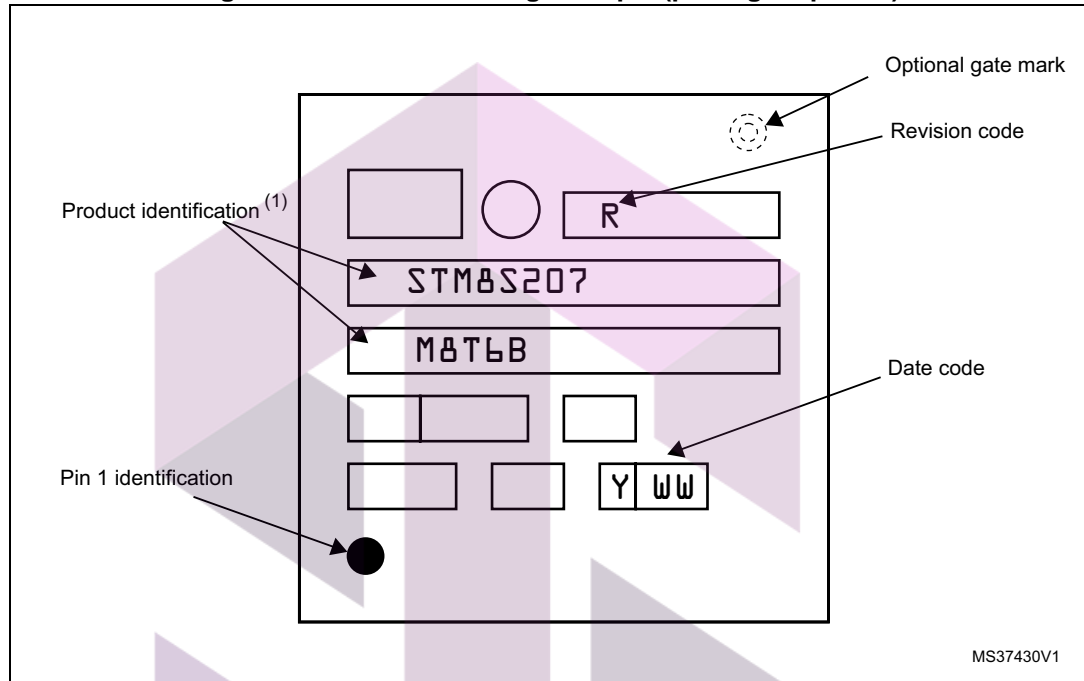


تهیه و توزیع قطعات الکترونیک

Device marking

The following figure shows the marking for the LQFP80 package.

Figure 45. LQFP80 marking example (package top view)



1. Parts marked as “ES”, “E” or accompanied by an Engineering Sample notification letter, are not yet qualified and therefore not yet ready to be used in production and any consequences deriving from such usage will not be at ST charge. In no event, ST will be liable for any customer usage of these engineering samples in production. ST Quality has to be contacted prior to any decision to use these Engineering samples to run qualification activity.

SKYTECH

تهیه و توزیع قطعات الکترونیک

11.1.2 LQFP64 package information

Figure 46. LQFP64 - 64-pin 14 mm x 14 mm low-profile quad flat package outline

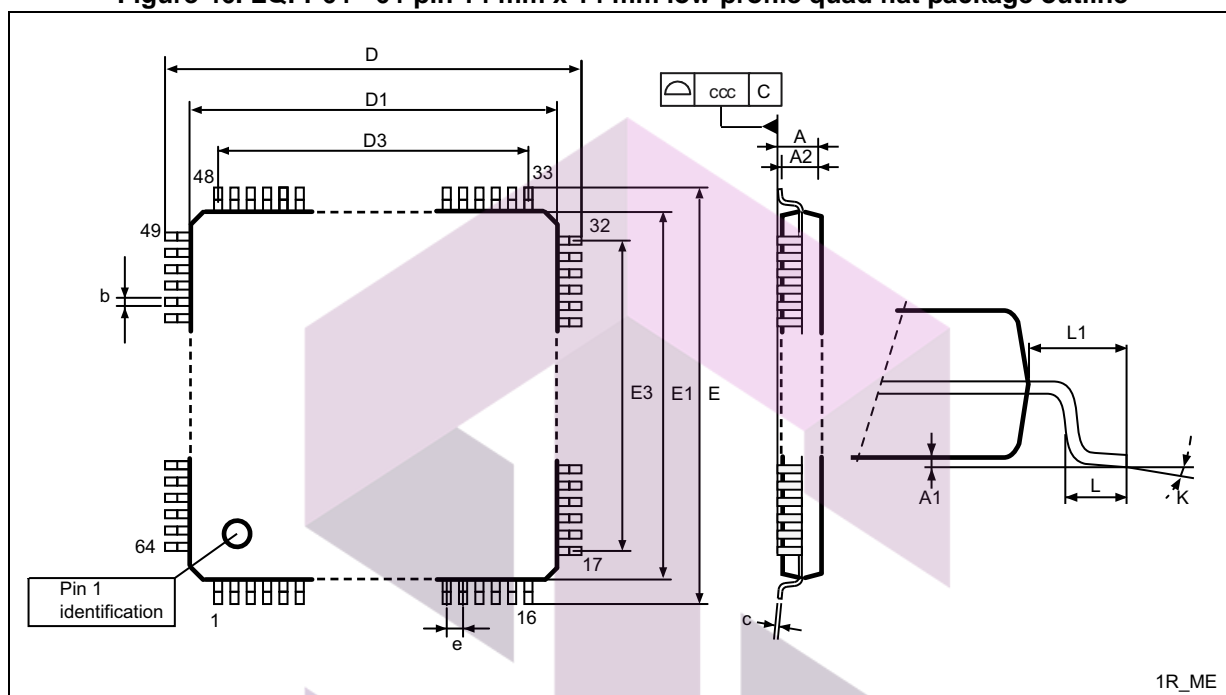


Table 52. LQFP64 - 64-pin, 14 x 14 mm low-profile quad flat package mechanical data

| Symbol | mm | | | inches ⁽¹⁾ | | |
|--------|--------|--------|--------|-----------------------|--------|--------|
| | Min | Typ | Max | Min | Typ | Max |
| A | | | 1.600 | | | 0.0630 |
| A1 | 0.050 | | 0.150 | 0.0020 | | 0.0059 |
| A2 | 1.350 | 1.400 | 1.450 | 0.0531 | 0.0551 | 0.0571 |
| b | 0.300 | 0.370 | 0.450 | 0.0118 | 0.0146 | 0.0177 |
| C | 0.090 | | 0.200 | 0.0035 | | 0.0079 |
| D | 15.800 | 16.000 | 16.200 | 0.6220 | 0.6299 | 0.6378 |
| D1 | 13.800 | 14.000 | 14.200 | 0.5433 | 0.5512 | 0.5591 |
| D3 | | 12.000 | | | 0.4724 | |
| E | 15.800 | 16.000 | 16.200 | 0.6220 | 0.6299 | 0.6378 |
| E1 | 13.800 | 14.000 | 14.200 | 0.5433 | 0.5512 | 0.5591 |
| E3 | | 12.000 | | | 0.4724 | |
| e | | 0.800 | | | 0.0315 | |
| L | 0.450 | 0.600 | 0.750 | 0.0177 | 0.0236 | 0.0295 |
| L1 | | 1.000 | | | 0.0394 | |

Table 52. LQFP64 - 64-pin, 14 x 14 mm low-profile quad flat package mechanical data (continued)

| Symbol | mm | | | inches ⁽¹⁾ | | |
|--------|-------|-------|-------|-----------------------|-------|--------|
| | Min | Typ | Max | Min | Typ | Max |
| k | 0.0 ° | 3.5 ° | 7.0 ° | 0.0 ° | 3.5 ° | 7.0 ° |
| ccc | | | 0.100 | | | 0.0039 |

1. Values in inches are converted from mm and rounded to four decimal places.

Figure 47. LQFP64 - 64-pin, 10 x 10 mm low-profile quad flat package outline

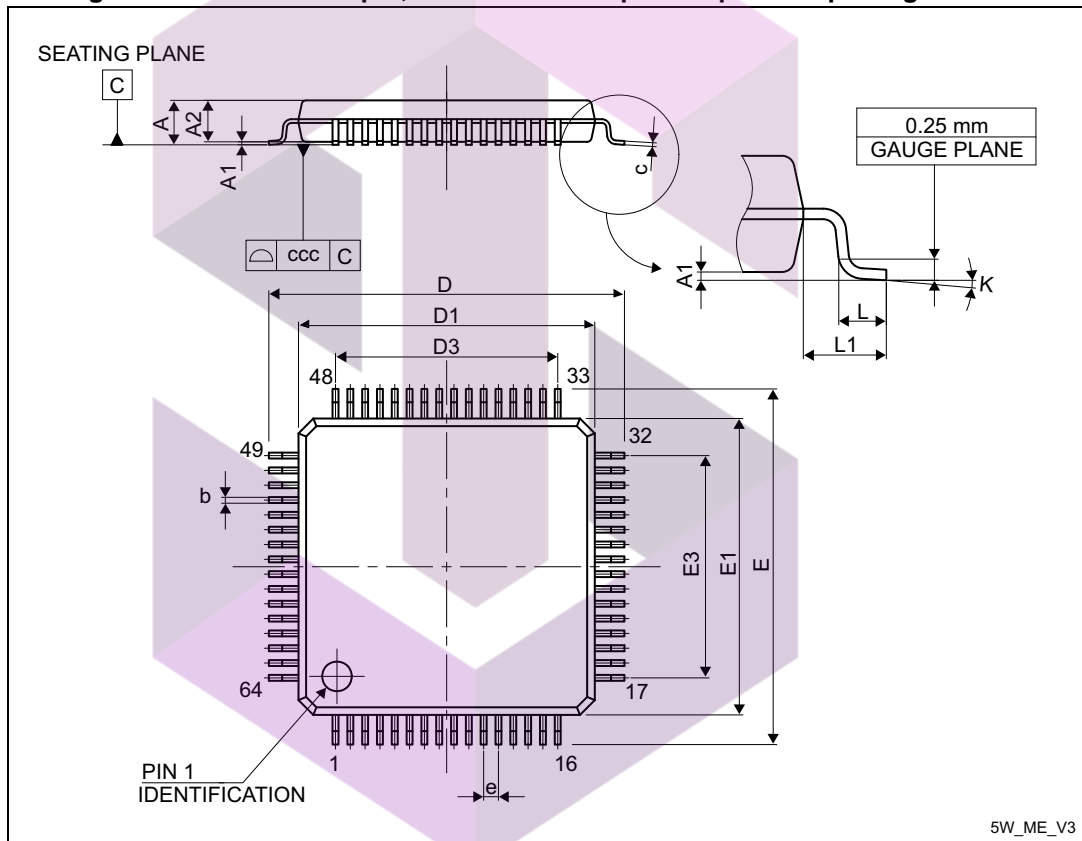


Table 53. LQFP64 - 64-pin, 10 x 10 mm low-profile quad flat package mechanical data

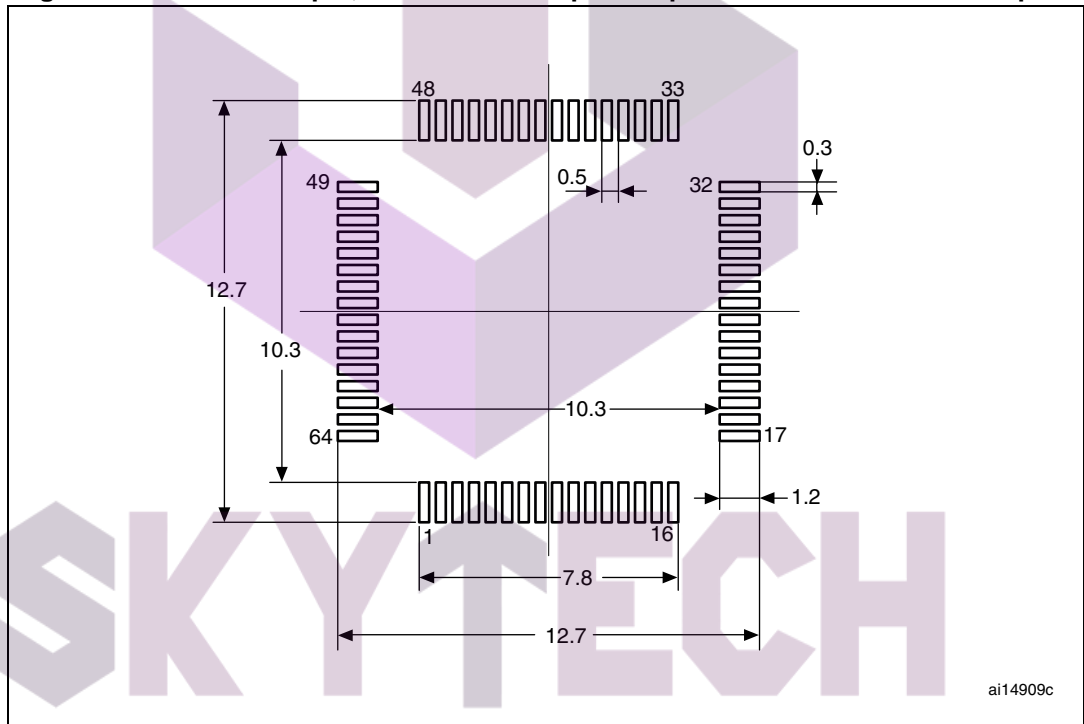
| Symbol | mm | | | inches ⁽¹⁾ | | |
|--------|-------|-------|-------|-----------------------|--------|--------|
| | Min | Typ | Max | Min | Typ | Max |
| A | - | - | 1.600 | - | - | 0.0630 |
| A1 | 0.050 | - | 0.150 | 0.0020 | - | 0.0059 |
| A2 | 1.350 | 1.400 | 1.450 | 0.0531 | 0.0551 | 0.0571 |
| b | 0.170 | 0.220 | 0.270 | 0.0067 | 0.0087 | 0.0106 |
| c | 0.090 | - | 0.200 | 0.0035 | - | 0.0079 |

Table 53. LQFP64 - 64-pin, 10 x 10 mm low-profile quad flat package mechanical data (continued)

| Symbol | mm | | | inches ⁽¹⁾ | | |
|--------|-------|--------|-------|-----------------------|--------|--------|
| | Min | Typ | Max | Min | Typ | Max |
| D | - | 12.000 | - | - | 0.4724 | - |
| D1 | - | 10.000 | - | - | 0.3937 | - |
| D3 | - | 7.500 | - | - | 0.2953 | - |
| E | - | 12.000 | - | - | 0.4724 | - |
| E1 | - | 10.000 | - | - | 0.3937 | - |
| E3 | - | 7.500 | - | - | 0.2953 | - |
| e | - | 0.500 | - | - | 0.0197 | - |
| θ | 0° | 3.5° | 7° | 0° | 3.5° | 7° |
| L | 0.450 | 0.600 | 0.750 | 0.0177 | 0.0236 | 0.0295 |
| L1 | - | 1.000 | - | - | 0.0394 | - |
| ccc | - | - | 0.080 | - | - | 0.0031 |

1. Values in inches are converted from mm and rounded to four decimal places.

Figure 48. LQFP64 - 64-pin, 10 x 10 mm low-profile quad flat recommended footprint

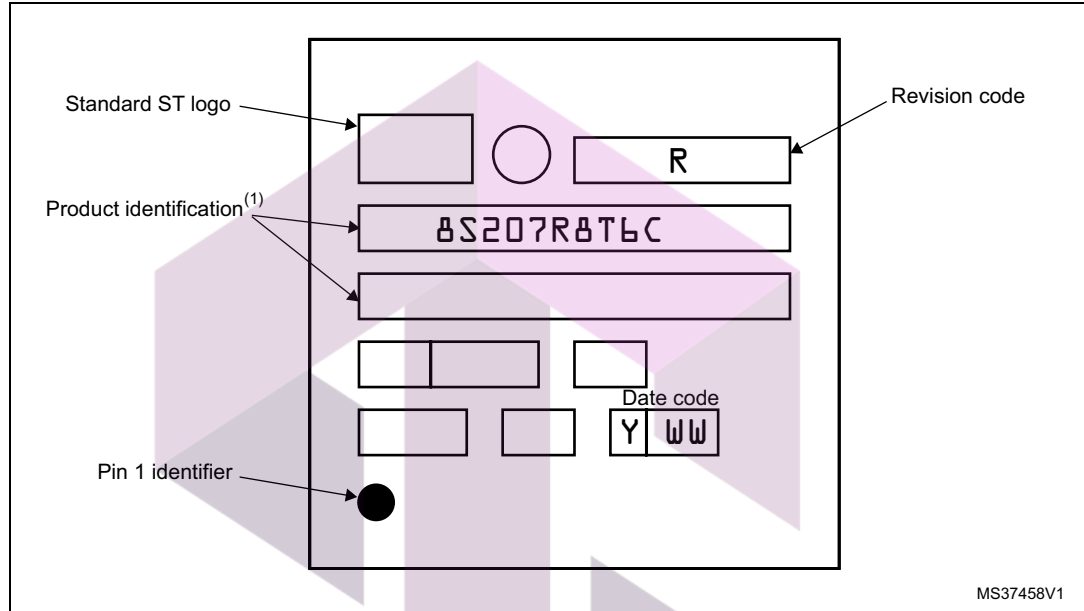


تهیه و توزیع قطعات الکترونیک

Device marking

The following figure shows the marking for the LQFP64 package.

Figure 49. LQFP64 marking example (package top view)



1. Parts marked as "ES", "E" or accompanied by an Engineering Sample notification letter, are not yet qualified and therefore not yet ready to be used in production and any consequences deriving from such usage will not be at ST charge. In no event, ST will be liable for any customer usage of these engineering samples in production. ST Quality has to be contacted prior to any decision to use these Engineering samples to run qualification activity.

SKYTECH

تهیه و توزیع قطعات الکترونیک

11.1.3 LQFP48 package information

Figure 50. LQFP48 - 48-pin, 7 x 7 mm low-profile quad flat package outline

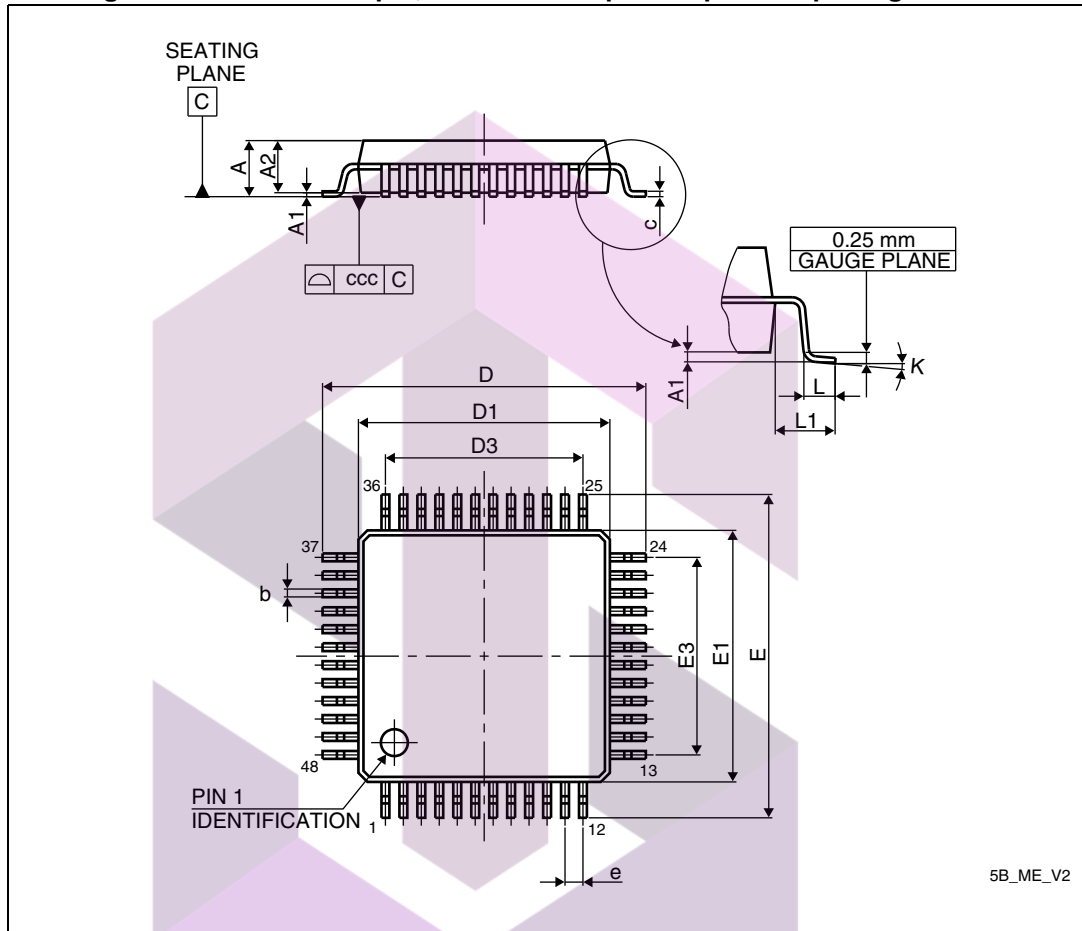


Table 54. LQFP48 - 48-pin, 7x 7 mm low-profile quad flat package mechanical

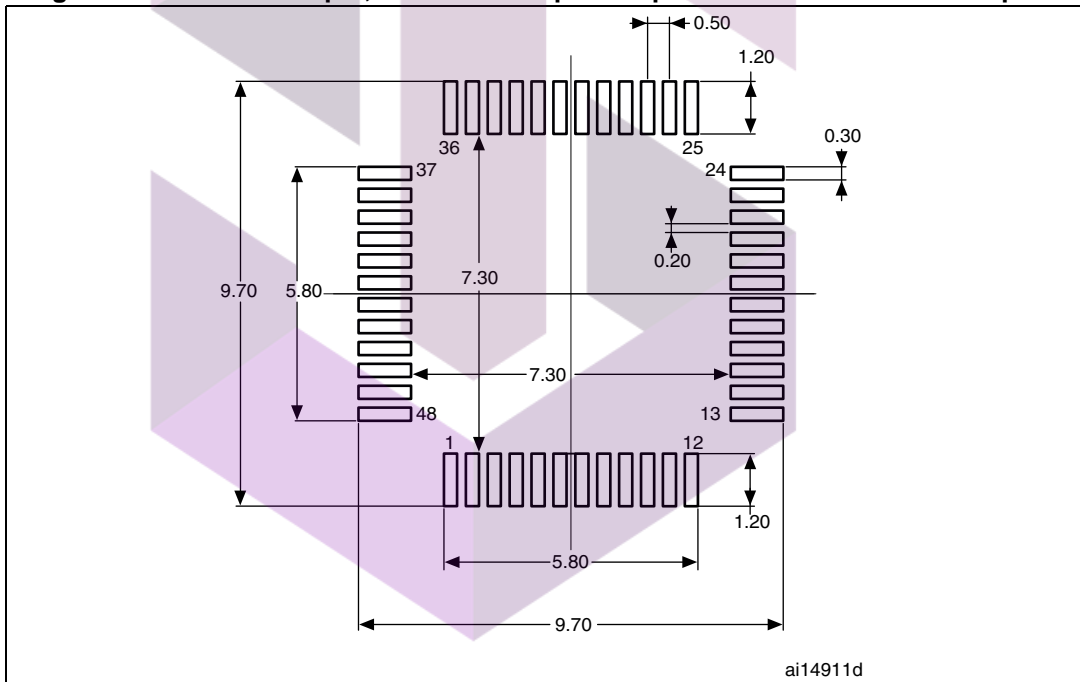
| Symbol | mm | | | inches ⁽¹⁾ | | |
|--------|-------|-------|-------|-----------------------|--------|--------|
| | Min | Typ | Max | Min | Typ | Max |
| A | - | - | 1.600 | - | - | 0.0630 |
| A1 | 0.050 | - | 0.150 | 0.0020 | - | 0.0059 |
| A2 | 1.350 | 1.400 | 1.450 | 0.0531 | 0.0551 | 0.0571 |
| b | 0.170 | 0.220 | 0.270 | 0.0067 | 0.0087 | 0.0106 |
| c | 0.090 | - | 0.200 | 0.0035 | - | 0.0079 |
| D | 8.800 | 9.000 | 9.200 | 0.3465 | 0.3543 | 0.3622 |
| D1 | 6.800 | 7.000 | 7.200 | 0.2677 | 0.2756 | 0.2835 |
| D3 | - | 5.500 | - | - | 0.2165 | - |
| E | 8.800 | 9.000 | 9.200 | 0.3465 | 0.3543 | 0.3622 |

Table 54. LQFP48 - 48-pin, 7x 7 mm low-profile quad flat package mechanical (continued)

| Symbol | mm | | | inches ⁽¹⁾ | | |
|--------|-------|-------|-------|-----------------------|--------|--------|
| | Min | Typ | Max | Min | Typ | Max |
| E1 | 6.800 | 7.000 | 7.200 | 0.2677 | 0.2756 | 0.2835 |
| E3 | - | 5.500 | - | - | 0.2165 | - |
| e | - | 0.500 | - | - | 0.0197 | - |
| L | 0.450 | 0.600 | 0.750 | 0.0177 | 0.0236 | 0.0295 |
| L1 | - | 1.000 | - | - | 0.0394 | - |
| k | 0° | 3.5° | 7° | 0° | 3.5° | 7° |
| ccc | - | - | 0.080 | - | - | 0.0031 |

1. Values in inches are converted from mm and rounded to four decimal places.

Figure 51. LQFP48 - 48-pin, 7 x 7 mm low-profile quad flat recommended footprint



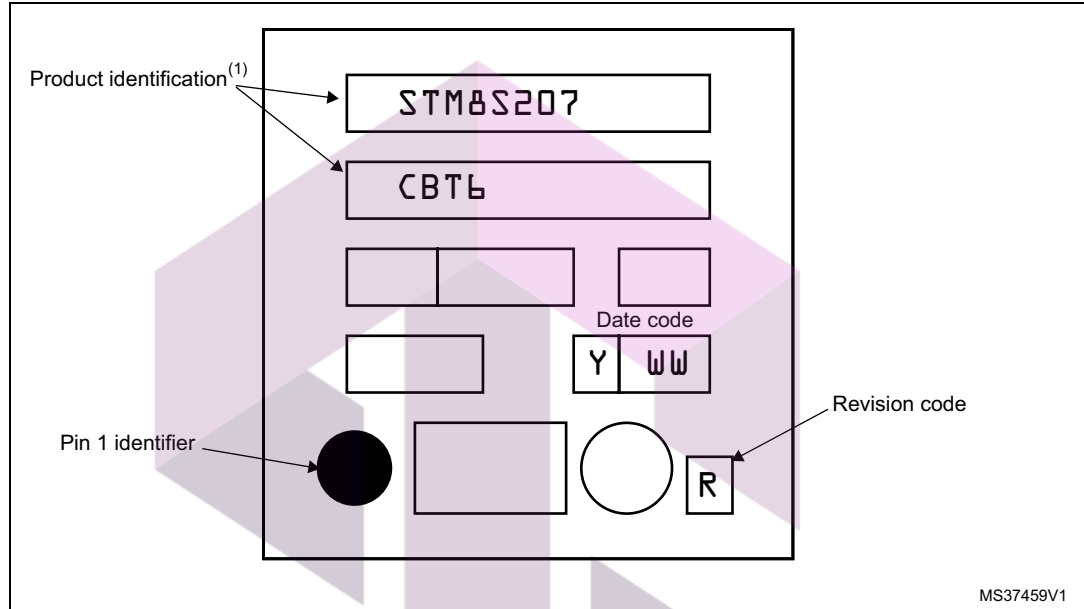
1. Dimensions are expressed in millimeters.



Device marking

The following figure shows the marking for the LQFP48 package.

Figure 52. LQFP48 marking example (package top view)



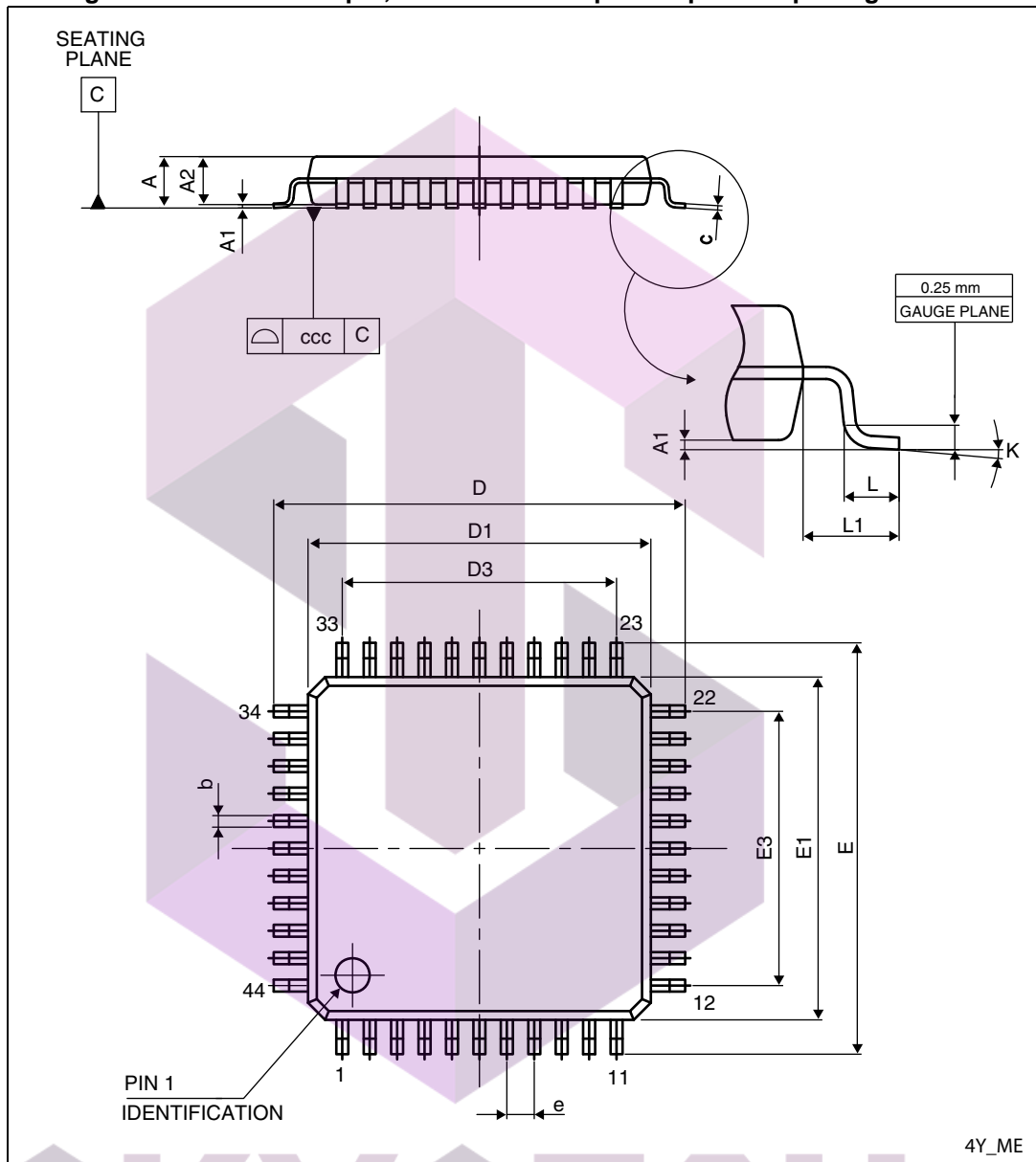
1. Parts marked as "ES", "E" or accompanied by an Engineering Sample notification letter, are not yet qualified and therefore not yet ready to be used in production and any consequences deriving from such usage will not be at ST charge. In no event, ST will be liable for any customer usage of these engineering samples in production. ST Quality has to be contacted prior to any decision to use these Engineering samples to run qualification activity.

SKYTECH

تهیه و توزیع قطعات الکترونیک

11.1.4 LQFP44 package information

Figure 53. LQFP44 - 44-pin, 10 x 10 mm low-profile quad flat package outline



SKYTECH

تهیه و توزیع قطعات الکترونیک

Table 55. LQFP44 - 44-pin, 10 x 10 mm low-profile quad flat package mechanical data

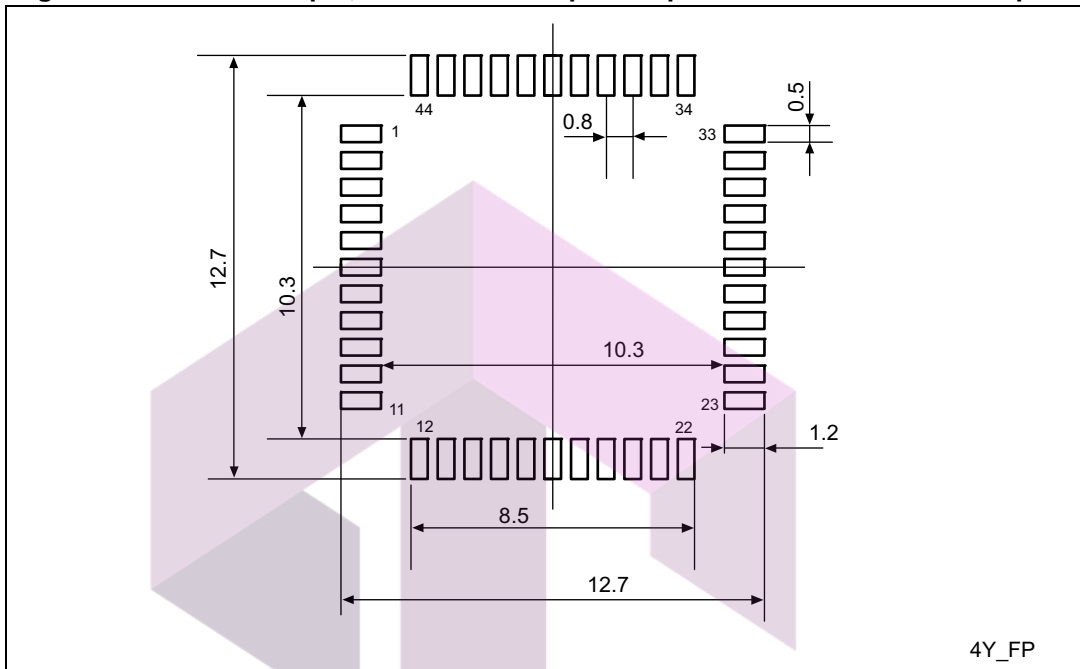
| Symbol | mm | | | inches ⁽¹⁾ | | |
|--------|--------|--------|--------|-----------------------|--------|--------|
| | Min | Typ | Max | Min | Typ | Max |
| A | - | - | 1.600 | - | - | 0.0630 |
| A1 | 0.050 | - | 0.150 | 0.0020 | - | 0.0059 |
| A2 | 1.350 | 1.400 | 1.450 | 0.0531 | 0.0551 | 0.0571 |
| b | 0.300 | 0.370 | 0.450 | 0.0118 | 0.0146 | 0.0177 |
| c | 0.090 | - | 0.200 | 0.0035 | - | 0.0079 |
| D | 11.800 | 12.000 | 12.200 | 0.4646 | 0.4724 | 0.4803 |
| D1 | 9.800 | 10.000 | 10.200 | 0.3858 | 0.3937 | 0.4016 |
| D3 | - | 8.000 | - | - | 0.3150 | - |
| E | 11.800 | 12.000 | 12.200 | 0.4646 | 0.4724 | 0.4803 |
| E1 | 9.800 | 10.000 | 10.200 | 0.3858 | 0.3937 | 0.4016 |
| E3 | - | 8.000 | - | - | 0.3150 | - |
| e | - | 0.800 | - | - | 0.0315 | - |
| L | 0.450 | 0.600 | 0.750 | 0.0177 | 0.0236 | 0.0295 |
| L1 | - | 1.000 | - | - | 0.0394 | - |
| k | 0.0° | 3.5° | 7.0° | 0.0° | 3.5° | 7.0° |
| ccc | - | - | 0.100 | - | - | 0.0039 |

1. Values in inches are converted from mm and rounded to four decimal places.



تهیه و توزیع قطعات الکترونیک

Figure 54. LQFP44 - 44-pin, 10 x 10 mm low-profile quad flat recommended footprint

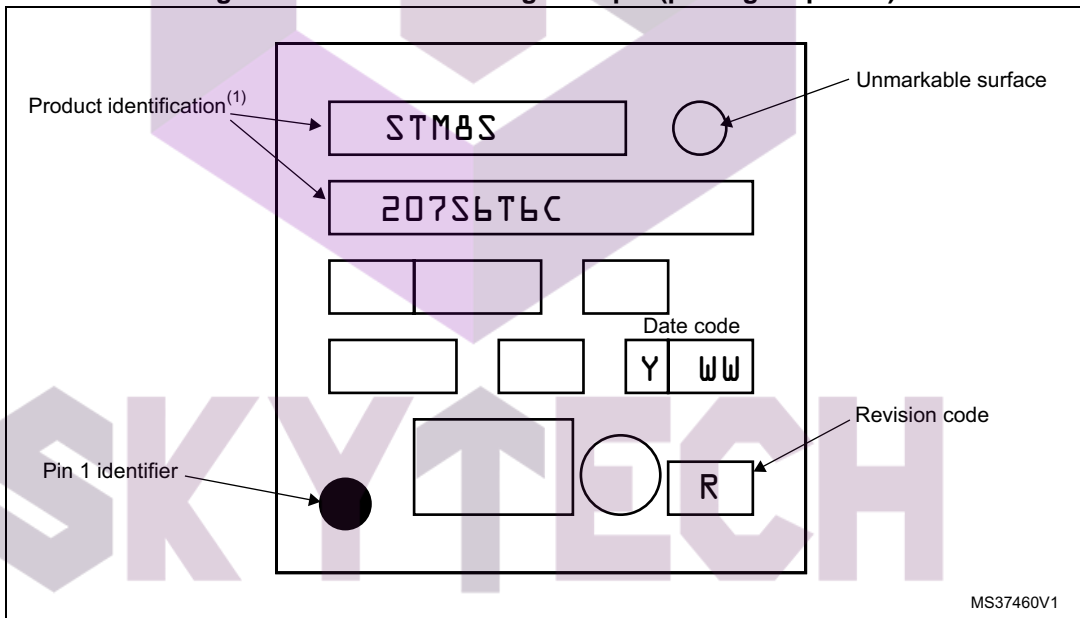


1. Dimensions are expressed in millimeters.

Device marking

The following figure shows the marking for the LQFP44 package.

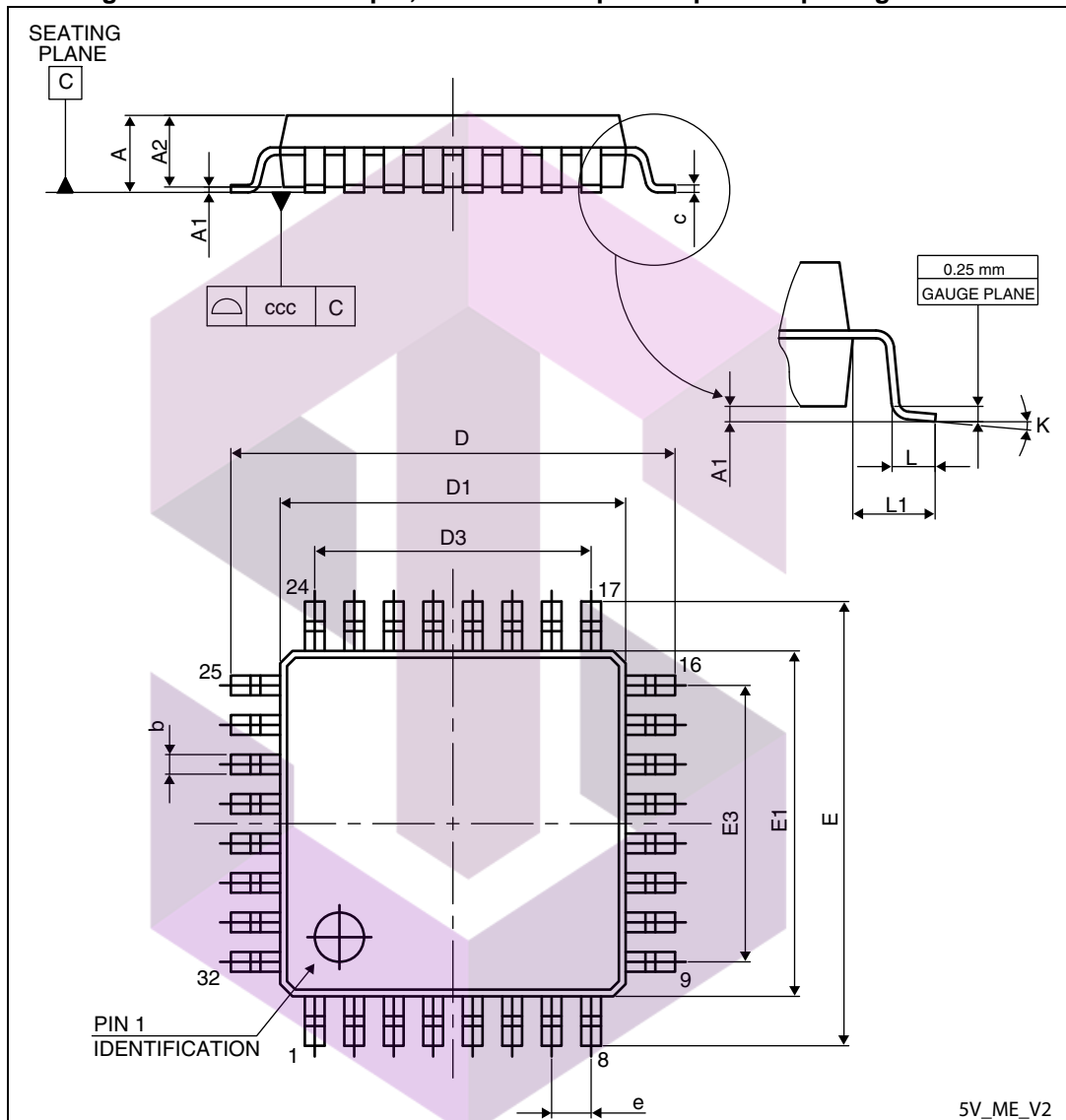
Figure 55. LQFP44 marking example (package top view)



1. Parts marked as “ES”, “E” or accompanied by an Engineering Sample notification letter, are not yet qualified and therefore not yet ready to be used in production and any consequences deriving from such usage will not be at ST charge. In no event, ST will be liable for any customer usage of these engineering samples in production. ST Quality has to be contacted prior to any decision to use these Engineering samples to run qualification activity.

11.1.5 LQFP32 package information

Figure 56. LQFP32 - 32-pin, 7 x 7 mm low-profile quad flat package outline



SKYTECH

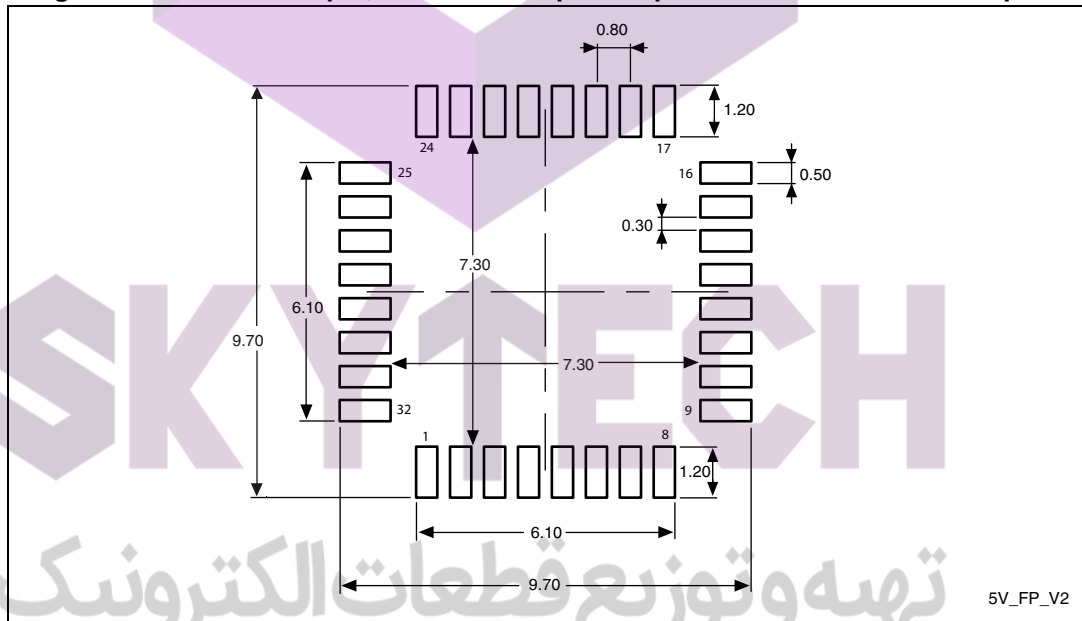
تهیه و توزیع قطعات الکترونیک

Table 56. LQFP32 - 32-pin, 7 x 7 mm low-profile quad flat package mechanical data

| Symbol | mm | | | inches ⁽¹⁾ | | |
|--------|-------|-------|-------|-----------------------|--------|--------|
| | Min | Typ | Max | Min | Typ | Max |
| A | - | - | 1.600 | - | - | 0.0630 |
| A1 | 0.050 | - | 0.150 | 0.0020 | - | 0.0059 |
| A2 | 1.350 | 1.400 | 1.450 | 0.0531 | 0.0551 | 0.0571 |
| b | 0.300 | 0.370 | 0.450 | 0.0118 | 0.0146 | 0.0177 |
| c | 0.090 | - | 0.200 | 0.0035 | - | 0.0079 |
| D | 8.800 | 9.000 | 9.200 | 0.3465 | 0.3543 | 0.3622 |
| D1 | 6.800 | 7.000 | 7.200 | 0.2677 | 0.2756 | 0.2835 |
| D3 | - | 5.600 | - | - | 0.2205 | - |
| E | 8.800 | 9.000 | 9.200 | 0.3465 | 0.3543 | 0.3622 |
| E1 | 6.800 | 7.000 | 7.200 | 0.2677 | 0.2756 | 0.2835 |
| E3 | - | 5.600 | - | - | 0.2205 | - |
| e | - | 0.800 | - | - | 0.0315 | - |
| L | 0.450 | 0.600 | 0.750 | 0.0177 | 0.0236 | 0.0295 |
| L1 | - | 1.000 | - | - | 0.0394 | - |
| k | 0° | 3.5° | 7° | 0° | 3.5° | 7° |
| ccc | - | - | 0.100 | - | - | 0.0039 |

1. Values in inches are converted from mm and rounded to four decimal places.

Figure 57. LQFP32 - 32-pin, 7 x 7 mm low-profile quad flat recommended footprint

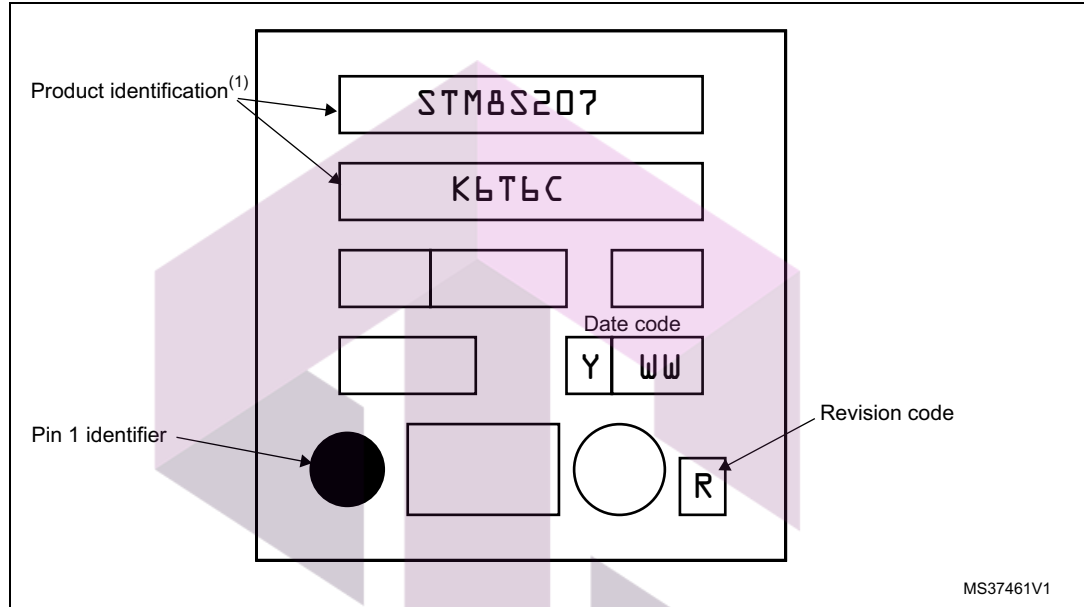


1. Dimensions are expressed in millimeters.

Device marking

The following figure shows the marking for the LQFP32 package.

Figure 58. LQFP32 marking example (package top view)



1. Parts marked as “ES”, “E” or accompanied by an Engineering Sample notification letter, are not yet qualified and therefore not yet ready to be used in production and any consequences deriving from such usage will not be at ST charge. In no event, ST will be liable for any customer usage of these engineering samples in production. ST Quality has to be contacted prior to any decision to use these Engineering samples to run qualification activity.

SKYTECH

تهیه و توزیع قطعات الکترونیک

11.2 Thermal characteristics

The maximum chip junction temperature (T_{Jmax}) must never exceed the values given in [Table 18: General operating conditions on page 56](#).

The maximum chip-junction temperature, T_{Jmax} , in degrees Celsius, may be calculated using the following equation:

$$T_{Jmax} = T_{Amax} + (P_{Dmax} \times \Theta_{JA})$$

Where:

- T_{Amax} is the maximum ambient temperature in °C
- Θ_{JA} is the package junction-to-ambient thermal resistance in °C/W
- P_{Dmax} is the sum of P_{INTmax} and $P_{I/Omax}$ ($P_{Dmax} = P_{INTmax} + P_{I/Omax}$)
- P_{INTmax} is the product of I_{DD} and V_{DD} , expressed in Watts. This is the maximum chip internal power.
- $P_{I/Omax}$ represents the maximum power dissipation on output pins, where:
 $P_{I/Omax} = \Sigma (V_{OL} * I_{OL}) + \Sigma (V_{DD} - V_{OH}) * I_{OH}$, and taking account of the actual V_{OL}/I_{OL} and V_{OH}/I_{OH} of the I/Os at low and high level in the application.

Table 57. Thermal characteristics⁽¹⁾

| Symbol | Parameter | Value | Unit |
|---------------|---|-------|------|
| Θ_{JA} | Thermal resistance junction-ambient LQFP 80 - 14 x 14 mm | 38 | °C/W |
| Θ_{JA} | Thermal resistance junction-ambient LQFP 64 - 14 x 14 mm | 45 | °C/W |
| Θ_{JA} | Thermal resistance junction-ambient LQFP 64 - 10 x 10 mm | 46 | °C/W |
| Θ_{JA} | Thermal resistance junction-ambient LQFP 48 - 7 x 7 mm | 57 | °C/W |
| Θ_{JA} | Thermal resistance junction-ambient LQFP 44 - 10 x 10 mm | 54 | °C/W |
| Θ_{JA} | Thermal resistance junction-ambient LQFP 32 - 7 x 7 mm | 60 | °C/W |

1. Thermal resistances are based on JEDEC JESD51-2 with 4-layer PCB in a natural convection environment.

11.2.1 Reference document

JESD51-2 integrated circuits thermal test method environment conditions - natural convection (still air). Available from www.jedec.org.



11.2.2 Selecting the product temperature range

When ordering the microcontroller, the temperature range is specified in the order code (see [Figure 59: STM8S207xx/208xx performance line ordering information scheme\(1\) on page 112](#)).

The following example shows how to calculate the temperature range needed for a given application.

Assuming the following application conditions:

- Maximum ambient temperature $T_{Amax} = 82\text{ °C}$ (measured according to JESD51-2)
- $I_{DDmax} = 15\text{ mA}$, $V_{DD} = 5.5\text{ V}$
- Maximum eight standard I/Os used at the same time in output at low level with $I_{OL} = 10\text{ mA}$, $V_{OL} = 2\text{ V}$
- Maximum four high sink I/Os used at the same time in output at low level with $I_{OL} = 20\text{ mA}$, $V_{OL} = 1.5\text{ V}$
- Maximum two true open drain I/Os used at the same time in output at low level with $I_{OL} = 20\text{ mA}$, $V_{OL} = 2\text{ V}$

$$P_{INTmax} = 15\text{ mA} \times 5.5\text{ V} = 82.5\text{ mW}$$

$$P_{IOmax} = (10\text{ mA} \times 2\text{ V} \times 8) + (20\text{ mA} \times 2\text{ V} \times 2) + (20\text{ mA} \times 1.5\text{ V} \times 4) = 360\text{ mW}$$

This gives: $P_{INTmax} = 82.5\text{ mW}$ and $P_{IOmax} = 360\text{ mW}$:

$$P_{Dmax} = 82.5\text{ mW} + 360\text{ mW}$$

$$\text{Thus: } P_{Dmax} = 443\text{ mW}$$

Using the values obtained in [Table 57: Thermal characteristics on page 108](#) T_{Jmax} is calculated as follows for LQFP64 10 x 10 mm = 46 °C/W:

$$T_{Jmax} = 82\text{ °C} + (46\text{ °C/W} \times 443\text{ mW}) = 82\text{ °C} + 20\text{ °C} = 102\text{ °C}$$

This is within the range of the suffix 6 version parts ($-40 < T_J < 105\text{ °C}$).

In this case, parts must be ordered at least with the temperature range suffix 6.

SKYTECH

تهیه و توزیع قطعات الکترونیک

12 STM8 development tools

Development tools for the STM8 microcontrollers include the full-featured STIce emulation system supported by a complete software tool package including C compiler, assembler and integrated development environment with high-level language debugger. In addition, the STM8 is to be supported by a complete range of tools including starter kits, evaluation boards and a low-cost in-circuit debugger/programmer.

12.1 Emulation and in-circuit debugging tools

The STIce emulation system offers a complete range of emulation and in-circuit debugging features on a platform that is designed for versatility and cost-effectiveness. In addition, STM8 application development is supported by a low-cost in-circuit debugger/programmer.

The STIce is the fourth generation of full featured emulators from STMicroelectronics. It offers new advanced debugging capabilities including profiling and coverage to help detect and eliminate bottlenecks in application execution and dead code when fine tuning an application.

In addition, STIce offers in-circuit debugging and programming of STM8 microcontrollers via the STM8 single wire interface module (SWIM), which allows non-intrusive debugging of an application while it runs on the target microcontroller.

For improved cost effectiveness, STIce is based on a modular design that allows you to order exactly what you need to meet the development requirements and to adapt the emulation system to support existing and future ST microcontrollers.

STIce key features

- Occurrence and time profiling and code coverage (new features)
- Advanced breakpoints with up to 4 levels of conditions
- Data breakpoints
- Program and data trace recording up to 128 KB records
- Read/write on the fly of memory during emulation
- In-circuit debugging/programming via SWIM protocol
- 8-bit probe analyzer
- 1 input and 2 output triggers
- Power supply follower managing application voltages between 1.62 to 5.5 V
- Modularity that allows you to specify the components you need to meet the development requirements and adapt to future requirements
- Supported by free software tools that include integrated development environment (IDE), programming software interface and assembler for STM8.

تهیه و توزیع قطعات الکترونیک

12.2 Software tools

STM8 development tools are supported by a complete, free software package from STMicroelectronics that includes ST Visual Develop (STVD) IDE and the ST Visual Programmer (STVP) software interface. STVD provides seamless integration of the Cosmic and Raisonance C compilers for STM8. A free version that outputs up to 32 Kbytes of code is available.

12.2.1 STM8 toolset

STM8 toolset with STVD integrated development environment and STVP programming software is available for free download at www.st.com/mcu. This package includes:

ST Visual Develop – Full-featured integrated development environment from ST, featuring

- Seamless integration of C and ASM toolsets
- Full-featured debugger
- Project management
- Syntax highlighting editor
- Integrated programming interface
- Support of advanced emulation features for STIce such as code profiling and coverage

ST Visual Programmer (STVP) – Easy-to-use, unlimited graphical interface allowing read, write and verification of the STM8 microcontroller Flash program memory, data EEPROM and option bytes. STVP also offers project mode for saving programming configurations and automating programming sequences.

12.2.2 C and assembly toolchains

Control of C and assembly toolchains is seamlessly integrated into the STVD integrated development environment, making it possible to configure and control the building of the application directly from an easy-to-use graphical interface.

Available toolchains include:

- **Cosmic C compiler for STM8** – One free version that outputs up to 32 Kbytes of code is available. For more information, see www.cosmic-software.com.
- **Raisonance C compiler for STM8** – One free version that outputs up to 32 Kbytes of code. For more information, see www.raisonance.com.
- **STM8 assembler linker** – Free assembly toolchain included in the STVD toolset, which allows you to assemble and link the application source code.

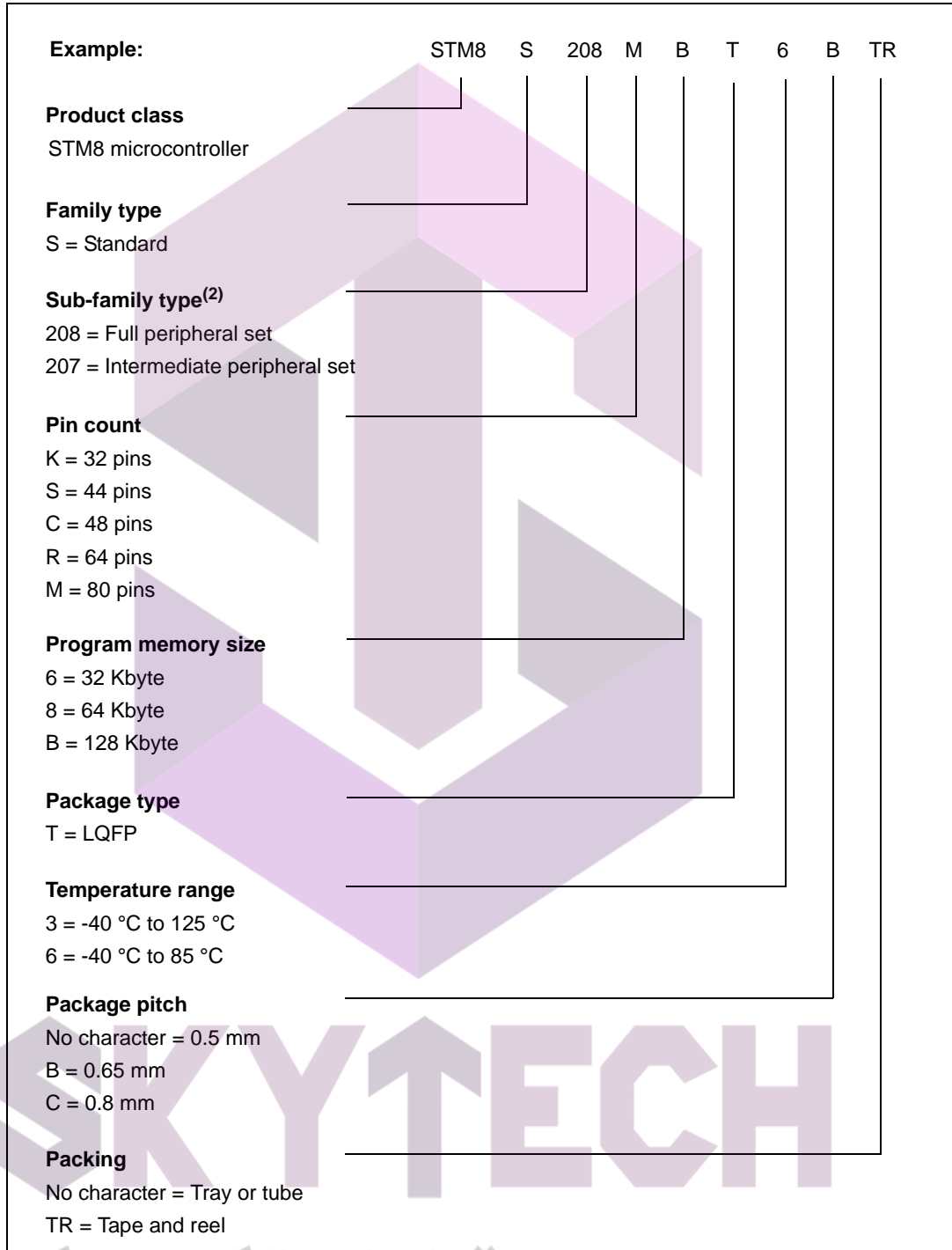
12.3 Programming tools

During the development cycle, STIce provides in-circuit programming of the STM8 Flash microcontroller on the application board via the SWIM protocol. Additional tools are to include a low-cost in-circuit programmer as well as ST socket boards, which provide dedicated programming platforms with sockets for programming the STM8.

For production environments, programmers will include a complete range of gang and automated programming solutions from third-party tool developers already supplying programmers for the STM8 family.

13 Ordering information

Figure 59. STM8S207xx/208xx performance line ordering information scheme⁽¹⁾



1. For a list of available options (e.g. memory size, package) and order-able part numbers or for further information on any aspect of this device, please go to www.st.com or contact the ST Sales Office nearest to you.
2. Refer to [Table 2: STM8S20xxx performance line features](#) for detailed description.

14 Revision history

Table 58. Document revision history

| Date | Revision | Changes |
|-------------|----------|--|
| 23-May-2008 | 1 | Initial release. |
| 05-Jun-2008 | 2 | Added part numbers on page 1 and in Table 2 on page 11 . Updated Section 4: Product overview . Updated Section 10: Electrical characteristics . |
| 22-Jun-2008 | 3 | Added part numbers on page 1 and in Table 2 on page 11 . |
| 12-Aug-2008 | 4 | Added 32 pin device pinout and ordering information. Updated UBC option description in Table 13 on page 48 . USART renamed UART1, LINUART renamed UART3. Max. ADC frequency increased to 6 MHz. |
| 20-Oct-2008 | 5 | Removed STM8S207K4 part number. Removed LQFP64 14 x 14 mm package. Added medium and high density Flash memory categories. Added Section 6: Memory and register map on page 34 . Replaced beCAN3 by beCAN in Section 4.14.5: beCAN . Updated Section 10: Electrical characteristics on page 52 . Updated LQFP44 (Figure 53 and Table 55), and LQFP32 outline and mechanical data (Figure 56 , and Table 56). |
| 08-Dec-2008 | 6 | Changed V_{DD} minimum value from 3.0 to 2.95 V. Updated number of High Sink I/Os in pinout. Removed FLASH_NFPR and FLASH_FPR registers in Table 9: General hardware register map . |
| 30-Jan-2009 | 7 | Removed preliminary status. Removed VQFN32 package. Added STM8S207C6, STM8S207S6. Updated external interrupts in Table 2 on page 11 . Updated Section 10: Electrical characteristics . |
| 10-Jul-2009 | 8 | Document status changed from "preliminary data" to "datasheet". Added LQFP64 14 x 14 mm package. Added STM8S207M8, STM8S207SB, STM8S208R8, STM8S208R6, STM8S208C8, and STM8S208C6, STM8S208SB, STM8S208S8, and STM8S208S6. Replaced "CAN" with "beCAN". Added Table 3 to Section 4.5: Clock controller . Updated Section 4.8: Auto wakeup counter . Added beCAN peripheral (impacting Table 1 and Figure 6). Added footnote about CAN_RX/TX to pinout figures 5 , 4 , and 6 . Table 6 : Removed 'X' from wpu column of I ² C pins (no wpu available). Added Table 11: Interrupt mapping . |

Table 58. Document revision history (continued)

| Date | Revision | Changes |
|-------------|-------------|--|
| 10-Jul-2009 | 8 cont'd | <p><i>Section 10: Electrical characteristics</i>: Added data for TBD values; updated <i>Table 15: Voltage characteristics</i> and <i>Table 18: General operating conditions</i>; updated VCAP specifications in <i>Table 18</i> and in <i>Section 10.3.1: VCAP external capacitor</i>; updated <i>Figure 18</i>; replaced <i>Figure 19</i>; updated <i>Table 35: RAM and hardware registers</i>; updated <i>Figure 22</i> and <i>Figure 35</i>; added <i>Figure 40: Typical application with I2C bus and timing diagram</i>.</p> <p>Removed <i>Table 56: Junction temperature range</i>.</p> <p>Added link between ordering information <i>Figure 59</i> and STM8S20xx features <i>Table 2</i>.</p> |
| 13-Apr-2010 | 9 | <p>Document status changed from "preliminary data" to "datasheet".</p> <p><i>Table 2: STM8S20xxx performance line features</i>: high sink I/O for STM8S207C8 is 16 (not 13).</p> <p><i>Table 3: Peripheral clock gating bit assignments in CLK_PCKENR1/2 registers</i>: updated bit positions for TIM2 and TIM3.</p> <p><i>Figure 5: LQFP 48-pin pinout</i>: added CAN_TX and CAN_RX to pins 35 and 36; noted that these pins are available only in STM8S208xx devices.</p> <p><i>Figure 7: LQFP 32-pin pinout</i>: replaced uart2 with uart3.</p> <p><i>Table 6: Pin description</i>: added footnotes concerning beCAN availability and UART1_RX and UART3_RX pins.</p> <p><i>Table 13: Option byte description</i>: added description of STM8L bootloader option bytes to the option byte description table.</p> <p>Added <i>Section 9: Unique ID</i> (and listed this attribute in <i>Features</i>).</p> <p><i>Section 10.3: Operating conditions</i>: added introductory text.</p> <p><i>Table 18: General operating conditions</i>: replaced "C_{EXT}" with "VCAP" and added data for ESR and ESL; removed "low power dissipation" condition for T_A.</p> <p><i>Table 26: Total current consumption in halt mode at VDD = 5 V</i>: replaced max value of I_{DD(H)} at 85 °C from 30 µA to 35 µA for the condition "Flash in power-down mode, HSI clock after wakeup".</p> <p><i>Table 33: HSI oscillator characteristics</i>: updated the ACC_{HSI} factory calibrated values.</p> <p><i>Functional EMS (electromagnetic susceptibility)</i> and <i>Table 47</i>: replaced "IEC 1000" with "IEC 61000".</p> <p><i>Electromagnetic interference (EMI)</i> and <i>Table 48</i>: replaced "SAE J1752/3" with "IEC 61967-2".</p> <p><i>Table 57: Thermal characteristics</i>: changed the thermal resistance junction-ambient value of LQFP32 (7x7 mm) from 59 °C/W to 60 °C/W.</p> |

SKYTECH

تهیه و توزیع قطعات الکترونیک

Table 58. Document revision history (continued)

| Date | Revision | Changes |
|-------------|----------|---|
| 14-Sep-2010 | 10 | <p>Added part number STM8S208M8 to Table 1: Device summary.</p> <p>Updated “reset state” of Table 5: Legend/abbreviations for pinout table.</p> <p>Added footnote 4 to Table 6: Pin description.</p> <p>Table 9: General hardware register map: standardized all reset state values; updated the reset state values of RST_SR, CLK_SWCR, CLK_HSITRIMR, CLK_SWIMCCR, IWDG_KR, and ADC_DRx registers; added the reset values of the CAN paged registers.</p> <p>Figure 36: Recommended reset pin protection: replaced 0.01 μF with 0.1 μF.</p> <p>Figure 40: Typical application with I2C bus and timing diagram: $t_w(\text{SCKH})$, $t_w(\text{SCKL})$, $t_r(\text{SCK})$, and $t_f(\text{SCK})$ replaced by $t_w(\text{SCLH})$, $t_w(\text{SCLL})$, $t_r(\text{SCL})$, and $t_f(\text{SCL})$ respectively.</p> |
| 22-Mar-2011 | 11 | <p>Table 1: Device summary: added STM8S207K8.</p> <p>Table 2: STM8S20xxx performance line features: added STM8S207K8 device and changed the RAM value of all other devices to 6 Kbytes.</p> <p>Figure 5, Figure 4, Figure 5, and Figure 7: removed TIM1_CH4 from pins 80, 64, 48, and 32 respectively.</p> <p>Table 6: Pin description: updated note 3 and added note 5.</p> <p>Table 9: General hardware register map: removed I2C_PECR register.</p> <p>Section 10.3.7: Reset pin characteristics: added text regarding the rest network.</p> |
| 10-Feb-2012 | 12 | <p>Figure 1: STM8S20xxx block diagram: updated POR/PDR and BOR; updated LINUART input; added legend.</p> <p>Table 18: General operating conditions: updated V_{CAP}.</p> <p>Table 26: Total current consumption in halt mode at VDD = 5 V: updated title, modified existing max column, and added new max column (at 125 °C) with data.</p> <p>Table 37: I/O static characteristics: added new condition and new max values for rise and fall time; added footnote 3; updated Typ and max pull-up resistor values.</p> <p>Section 10.3.7: Reset pin characteristics: updated cross reference in text below Figure 35</p> <p>Table 41: NRST pin characteristics: updated Typ and max values of the NRST pull-up resistor.</p> |

SKYTECH

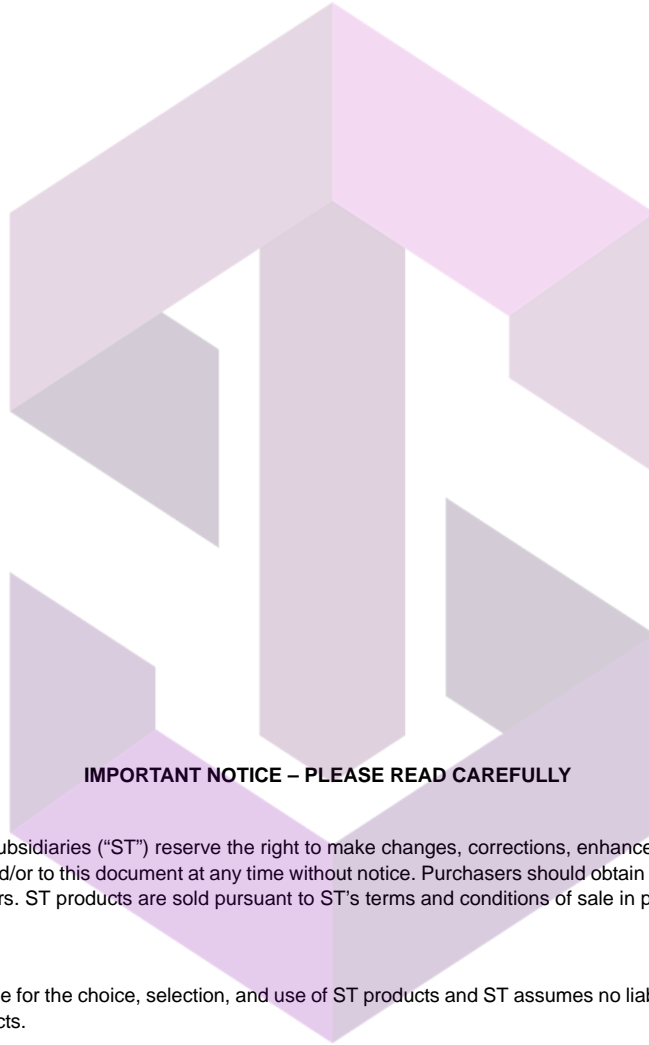
تهیه و توزیع قطعات الکترونیک

Table 58. Document revision history (continued)

| Date | Revision | Changes |
|-------------|----------|---|
| 18-Feb-2015 | 13 | <p>Updated:</p> <ul style="list-style-type: none"> - <i>Figure 43: LQFP80 - 80-pin, 14 x 14 mm low-profile quad flat package outline</i> - <i>Table 51: LQFP80 - 80-pin, 14 x 14 mm low-profile quad flat package mechanical data</i> - <i>Figure 51: LQFP80 - 80-pin, 14 x 14 mm low-profile quad flat package mechanical data</i> - <i>Figure 47: LQFP64 - 64-pin, 10 x 10 mm low-profile quad flat package outline</i> - <i>Table 53: LQFP64 - 64-pin, 10 x 10 mm low-profile quad flat package mechanical data</i> - <i>Figure 50: LQFP48 - 48-pin, 7 x 7 mm low-profile quad flat package outline</i> - <i>Table 54: LQFP48 - 48-pin, 7x 7 mm low-profile quad flat package mechanical</i> - <i>Figure 56: LQFP32 - 32-pin, 7 x 7 mm low-profile quad flat package outline</i> - <i>Table 56: LQFP32 - 32-pin, 7 x 7 mm low-profile quad flat package mechanical data</i> <p>Added:</p> <ul style="list-style-type: none"> - <i>Figure 44: LQFP80 recommended footprint</i> - <i>Figure 45: LQFP80 marking example (package top view)</i> - <i>Figure 48: LQFP64 - 64-pin, 10 x 10 mm low-profile quad flat recommended footprint</i> - <i>Figure 49: LQFP64 marking example (package top view)</i> - <i>Figure 51: LQFP48 - 48-pin, 7 x 7 mm low-profile quad flat recommended footprint</i> - <i>Figure 52: LQFP48 marking example (package top view)</i> - <i>Figure 54: LQFP44 - 44-pin, 10 x 10 mm low-profile quad flat recommended footprint</i> - <i>Figure 55: LQFP44 marking example (package top view)</i> - <i>Figure 57: LQFP32 - 32-pin, 7 x 7 mm low-profile quad flat recommended footprint</i> - <i>Figure 58: LQFP32 marking example (package top view)</i> |

SKYTECH

تهيئه وتوزيع قطعات الكترولنيك



IMPORTANT NOTICE – PLEASE READ CAREFULLY

STMicroelectronics NV and its subsidiaries ("ST") reserve the right to make changes, corrections, enhancements, modifications, and improvements to ST products and/or to this document at any time without notice. Purchasers should obtain the latest relevant information on ST products before placing orders. ST products are sold pursuant to ST's terms and conditions of sale in place at the time of order acknowledgement.

Purchasers are solely responsible for the choice, selection, and use of ST products and ST assumes no liability for application assistance or the design of Purchasers' products.

No license, express or implied, to any intellectual property right is granted by ST herein.

Resale of ST products with provisions different from the information set forth herein shall void any warranty granted by ST for such product.

ST and the ST logo are trademarks of ST. All other product or service names are the property of their respective owners.

Information in this document supersedes and replaces information previously supplied in any prior versions of this document.

تهیه و توزیع قطعات الکترونیک
© 2015 STMicroelectronics – All rights reserved